

Service Service Service

CL 96532086_000.eps
08/09/99

Service Manual



SERVICING

For servicing CDR779, the set can be divided into three parts

1. The display board (partly) 1002, the I/O board 1004, the headphone board (partly) 1002, the IR board (partly) 1002, the ON/OFF & Standby LED board (partly) 1002 and the CD-out board (partly) 1002 have to be repaired at component level. The power supply unit 1003 is available as spare part, but can also be repaired at component level.
2. The CDR module (containing the CDR loader 81, CDR main board 1001 and loader bracket 82, 83) can also be repaired at component level with the help of COMPAIR release 1.6 and higher. With this tool the diagnosing of the set can be done in an interactive way. In the tool also the adjustment procedure has been implemented. This is absolutely necessary in case the CDR mainboard and/or (CDR loader) CDM is disconnected from the matched production combination. Only designated workshops can perform these repairs. Please send the complete set to the designated workshop.
3. The CD module (containing the CD loader 131, CD mainboard 1005 and loader bracket 132) is a new module with VAL1250 loader assy but also a separate CDM and separate loader parts will be available via service stock. The CD mainboard can be repaired at component level.

Also available : Circuit Description "The Basics of Compact Disc Recordable/Rewriteable". Service codenumber 4822 725 25242.
Second line Repairmanual . Service codenumber 3104 125 40110.

Contents

	Page
1. Technical Specifications	2
2. Warning and Servicing Hints	4
3. User Instructions	7
4. <i>Mechanical Instructions</i>	
Wiring Diagram CDR	19
Wiring Diagram CD loader	20
Exploded View CDR	21
Exploded View CD loader	22
Dismantling Instructions	23
5. <i>Block diagram, Circuit diagrams and PWB's</i>	<i>Diagram PWB</i>
Overall Blockdiagram	24
Display Board	25 26
IR / On/Off & Standby LED Board	27 27
Headphone / CD-out Board	28 28
I/O Board: EXT DAC (Diagram 1)	29 35
I/O Board: Cinch (Diagram 2)	30 35
I/O Board: Mic ADC (Diagram 3)	31 35
I/O Board: Power supply (Diagram 4)	32 35
I/O Board: DAC filter (Diagram 5)	33 35
I/O Board: DAC (Diagram 6)	34 35
Power Supply Unit	36 37
CD-Mainboard: Decoder & Servo (Diagram 1A)	38 42/43
CD-Mainboard: Servo drivers (Diagram 1B)	39 42/43
CD-Mainboard: Audio (Diagram 1C)	40 42/43
CD-Mainboard: Microprocessor (Diagram 2)	41 42/43
6. Diagnostic Software	45
7. Faultfinding Trees	49
8. Faultfinding Guide	55
9. List of Abbreviations	69
10. Partslist (mechanical and electrical)	75

© Copyright 2000 Philips Consumer Electronics B.V. Eindhoven, The Netherlands.
All rights reserved. No part of this publication may be reproduced, stored in a retrieval system or transmitted, in any form or by any means, electronic, mechanical, photocopying, or otherwise without the prior permission of Philips.



PHILIPS

1. Technical Specifications CDR779

1.1 General

Mains voltage	: all range version 84-230V
Mains frequency	: 50-60 Hz
Power consumption	: 12W
DC output	: +5V ± 10%, 50mA max.

Dynamic range	: typical: 98dB. : > 94dB. at 1kHz.
THD+N	: typical: 95dB. : > 89dB from 20Hz. until 20kHz. : typical: 90dB.

1.2 Input/output

1.2.1 Line output (CDR & CD)

Output level	: 2Vrms at 0dB
Output resistance	: 200Ω

1.2.2 Line input

Input sensitivity	: 500mVrms
Input impedance	: 50kΩ
Max. input voltage	: 2.5Vrms

1.2.3 Digital output (CDR & CD)

Format	: AES/EBU format according IEC958 (consumer format)
Sampling frequency	: 44.1kHz
Output resistance	: 75Ω

1.2.4 Digital input

Format	: AES/EBU format according IEC958 (consumer format)
Sampling frequency	: 32 to 48kHz
Input resistance	: 75Ω

1.2.5 Optical input

Format	: AES/EBU format according IEC958 (consumer format)
Sampling frequency	: 32 to 48kHz

1.3 Audio performance

1.3.1 Cinch analog output (CDR play-back)

Output voltage	: 2Vrms ± 2dB. (0dB digital).
Frequency range F.R.	: 20Hz < F.R. < 20kHz.
Amplitude linearity	: ± 0.15dB. : typical.: ± 0.1dB.
Channel unbalance	: <0.3dB at 1kHz. : typical: ± 0.2dB.
Phase non-linearity	: <0.2deg at 1kHz.
Outband attenuation	: 50dB above 30kHz.
Channel separation	: >100dB at 1kHz. : typical: 110dB. : >84dB from 20Hz. until 20kHz. : typical: >85dB.
S/N-ratio A-weighted	: >99dB. : typical: 100dB.
S/N-ratio unweightes	: >97dB.

1.3.2 Cinch analog input/output (monitor path CDR)

Measured with Audio precision system one. Input voltage is 2Vrms.

input voltage	: 2Vrms ± 2dB. (0dB digital).
Frequency range F.R.	: 20Hz < F.R. < 20kHz.
Amplitude linearity	: ± 0.2dB. : typical.: ± 0.1dB.
Channel unbalance	: < 0.2dB at 1kHz. : typical: ± 0.15dB.
Input resistance	: 25k(
Phase non-linearity	: < 0.2deg at 1kHz.
Outband attenuation	: 50dB above 30kHz.
Channel separation	: > 90dB at 1kHz. : typical: 100dB.
S/N-ratio A-weighted	: > 87dB. : typical: 93dB.
S/N-ratio unweighted	: > 87dB. : typical: 90dB.
Dynamic range	: > 86dB. at 1kHz. : typical: 90dB. : > 86dB from 20Hz. until 20kHz. : typical: 90dB.
THD+N	: > 86dB from 20Hz. until 20kHz. : typical: 87dB.

1.3.3 Cinch analog output (CD play-back)

Output voltage	: 2Vrms ± 2dB. (0dB digital).
Frequency range F.R.	: 20Hz < F.R. < 20kHz.
Amplitude linearity	: ± 0.3dB. : typical.: ± 0.1dB.
Channel unbalance	: <0.3dB at 1kHz. : typical: ± 0.2dB.
Output resistance	: 200(
Phase non-linearity	: <0.2deg at 1kHz.
Outband attenuation	: 60dB above 30kHz.
Channel separation	: >95dB at 1kHz. : typical: 100dB. : >90dB from 20Hz. until 20kHz. : typical: >93dB.
S/N-ratio A-weighted	: >98dB. : typical: 100dB.
S/N-ratio unweighted	: >92dB. : typical: 95dB.
Dynamic range	: >92dB. at 1kHz. : typical: 96dB. : >90dB from 20Hz. until 20kHz. : typical: 96dB.
THD+N	: >82dB from 20Hz. until 20kHz. : typical: 85dB.

1.3.4 Headphone output (all functions)

Output voltage	: 2Vrms (0dB)/16Ω
S/N	: > 80dB
THD+N	: > 78dB
Channel separation	: > 60dB between 20Hz until 20kHz

1.4 Laser device

Material	: GaAIAs
Wave length	: between 780 and 800nm (at 25°C)
Laser output	: 1mW max. during reading, 20mW max. during writing
Class	: 3B

1.5 Dimensions and weight

Number and height of feet	: 4x11mm foiled
Apparatus tray closed (WxDxH)	: 435x305x75mm (without feet)
Weight without packaging	: 3.2kg
Weight with packaging	: 4.2kg

2. Warnings and Servicing Hints

GB WARNING

All ICs and many other semi-conductors are susceptible to electrostatic discharges (ESD). Careless handling during repair can reduce life drastically.

When repairing, make sure that you are connected with the same potential as the mass of the set via a wrist wrap with resistance.

Keep components and tools also at this potential.



NL WAARSCHUWING

Alle IC's en vele andere halfgeleiders zijn gevoelig voor elektrostatische ontladingen (ESD).

Onzorgvuldig behandelen tijdens reparatie kan de levensduur drastisch doen verminderen.

Zorg ervoor dat u tijdens reparatie via een polsband met weerstand verbonden bent met hetzelfde potentiaal als de massa van het apparaat.

Houd componenten en hulpmiddelen ook op ditzelfde potentiaal.

F ATTENTION

Tous les IC et beaucoup d'autres semi-conducteurs sont sensibles aux décharges statiques (ESD).

Leur longévité pourrait être considérablement écourtée par le fait qu'aucune précaution n'est prise à leur manipulation.

Lors de réparations, s'assurer de bien être relié au même potentiel que la masse de l'appareil et enfiler le bracelet serti d'une résistance de sécurité.

Veiller à ce que les composants ainsi que les outils que l'on utilise soient également à ce potentiel.

D WARNUNG

Alle IC und viele andere Halbleiter sind empfindlich gegen elektrostatische Entladungen (ESD).

Unvorsichtige Behandlung bei der Reparatur kann die Lebensdauer drastisch vermindern. Sorgen sie dafür, das Sie im Reparaturfall über ein Pulsarmband mit Widerstand mit dem Massepotential des Gerätes verbunden sind.

Halten Sie Bauteile und Hilfsmittel ebenfalls auf diesem Potential.

I AVVERTIMENTO

Tutti IC e parecchi semi-conduttori sono sensibili alle scariche statiche (ESD).

La loro longevità potrebbe essere fortemente ridotta in caso di non osservazione della più grande cauzione alla loro manipolazione. Durante le riparazioni occorre quindi essere collegato allo stesso potenziale che quello della massa dell'apparecchio tramite un braccialetto a resistenza.

Assicurarsi che i componenti e anche gli utensili con quali si lavora siano anche a questo potenziale.

GB

Safety regulations require that the set be restored to its original condition and that parts which are identical with those specified be used.

NL

Veiligheidsbepalingen vereisen, dat het apparaat in zijn oorspronkelijke toestand wordt terug gebracht en dat onderdelen, identiek aan de gespecificeerde worden toegepast.

D

Bei jeder Reparatur sind die geltenden Sicherheitsvorschriften zu beachten. Der Originalzustand des Gerats darf nicht verändert werden. Für Reparaturen sind Original-Ersatzteile zu verwenden.

I

Le norme di sicurezza esigono che l'apparecchio venga rimesso nelle condizioni originali e che siano utilizzati pezzi di ricambio identici a quelli specificati.

F

Les normes de sécurité exigent que l'appareil soit remis à l'état d'origine et que soient utilisées les pièces de rechange identiques à celles spécifiées.



**CAUTION
VARO!
WARNING
ADVERSEL
DANGER
VORSICHT**

INVISIBLE LASER RADIATION WHEN OPEN. AVOID EXPOSURE TO BEAM.
AVATTAESSA OLET ALTIINA NÄKYMÄTTÖMÄLLE LASER SÄTTEILYLLE ÄLÄ KATSO SÄTEESEN.
OSYNLIG LASERSTRÅLNING NÄR DENNA DEL ÄR ÖPPNAD BETRAKTA EJ STRÅLEN.
USYNLIG LASERSTRÅLNING VID ÅBNING. UNDGA UNSÄTTELSE FÖR STRÅLNING.
INVISIBLE LASER RADIATION WHEN OPEN. AVOID DIRECT EXPOSURE TO BEAM.
UNSICHTBARE LASERSTRALHUNG WENN ABDECKUNG GEÖFFNET. NICHT DEM STRAHL AUSSETZEN.

SHOCK, FIRE HAZARD SERVICE TEST:

CAUTION: After servicing this appliance and prior to returning to customer, measure the resistance between either primary AC cord connector pins (with unit NOT connected to AC mains and its Power switch ON), and the face or Front Panel of product and controls and chassis bottom,

Any resistance measurement less than 1 Megohms should cause unit to be repaired or corrected before AC power is applied, and verified before return to user/customer.

Ref.UL Standard NO.1492.

NOTE ON SAFETY:

Symbol : Fire or electrical shock hazard. Only original parts should be used to replace any part with symbol Any other component substitution (other than original type), may increase risk of fire or electrical shock hazard.

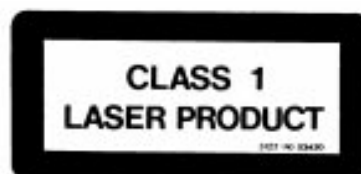

Pour votre sécurité, ces documents doivent être utilisés par des spécialistes agréés, seuls habilités à réparer votre appareil en panne.

SERVICING HINTS

In the set, chip components have been applied. For disassembly and assembly check the figure below.

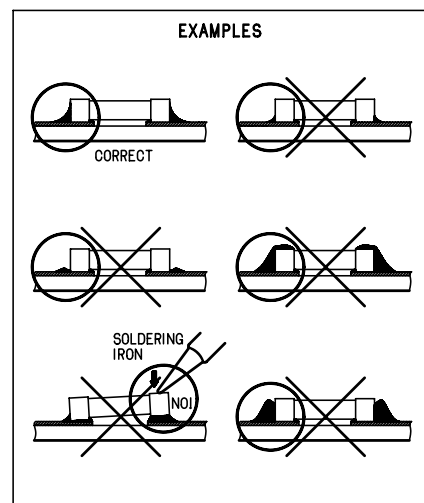
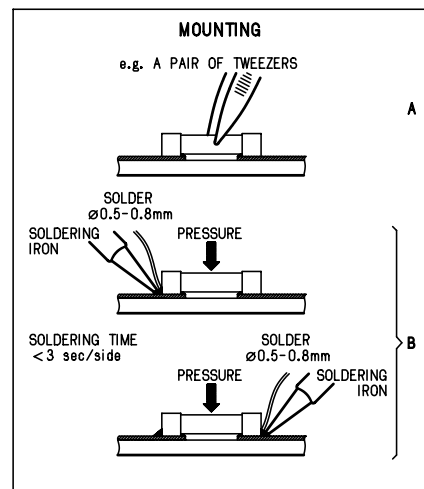
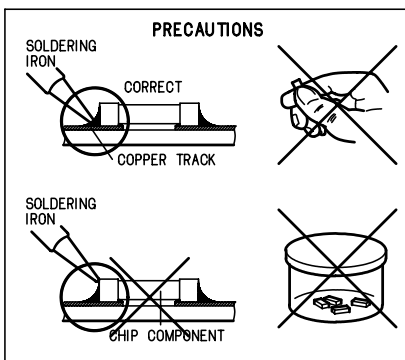
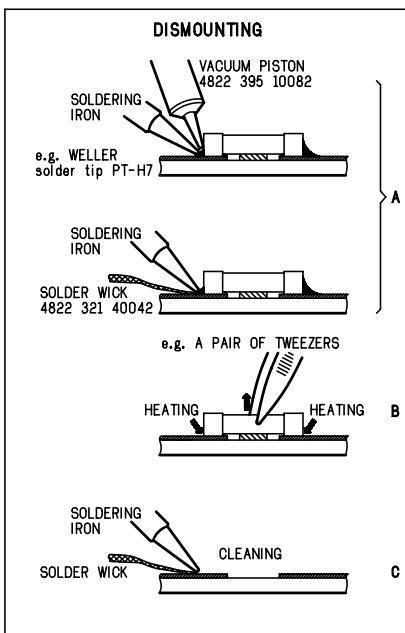
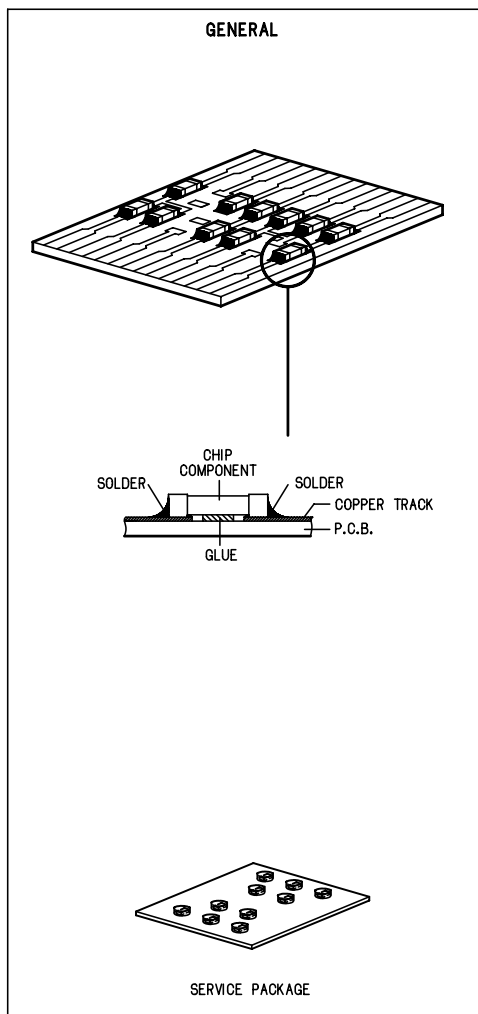

SAFETY GUIDELINES FOR THE PROFESSIONAL SERVICE TECHNICIAN

Important

Proper service and repair is important to the safe, reliable operation of all Philips equipment. The service procedures recommended by Philips and described in this service manual are effective methods of performing service operations. Some of these service operations require the use of tools specially designed for the purpose. The special tools should be used when and as recommended.

It is important to note that this manual contains various CAUTIONS and NOTICES which should be carefully read in order to minimize the risk of personal injury to service personnel. The possibility exists that improper service methods may damage the equipment. It also is important to understand that these CAUTIONS and NOTICES ARE NOT EXHAUSTIVE. Philips could not possibly know, evaluate and advise the service trade of all conceivable ways in which service might be done or of the possible hazardous consequences of each way. Consequently, Philips has not undertaken any such broad evaluation. Accordingly, a servicer who uses a service procedure or tool which is not recommended by Philips must first satisfy himself thoroughly that neither his safety nor the safe operation of the equipment will be jeopardized by the service method selected.

Safety Checks

After the original service problem has been corrected, a complete safety check should be made. Be sure to check over the entire set, not just the areas where you have worked. Some previous servicer may have left an unsafe condition, which could be unknowingly passed on to your customer. Be sure to check all of the following:

Fire and Shock Hazard

1. Be sure all components are positioned in such a way as to avoid the possibility of adjacent component shorts. This is especially important on those units which are transported to and from the service shop.
2. Never release a repaired unit unless all protective devices such as insulators, barriers, covers, strain reliefs, and other hardware have been installed according to the original design.
3. Soldering and wiring must be inspected to locate possible cold solder joints, solder splashes, sharp solder points, frayed leads, pinched leads, or damaged insulation (including the ac cord). Be certain to remove loose solder balls and all other loose foreign particles.
4. Check across-the-line components and other components for physical evidence of damage or deterioration and replace if necessary. Follow original layout, lead length, and dress.
5. No lead or component should touch a resistor rated at 1 watt or more. Lead tension around protruding metal surfaces or edges must be avoided.
6. Critical components having special safety characteristics are identified with a \blacktriangle by the Ref. No. in the parts list and enclosed within a broken line* (where several critical components are grouped in one area) along with the safety symbol \blacktriangle on the schematic diagrams and/or exploded views.

Replacement parts without the same safety characteristics may create shock, fire, or other hazards.

7. When servicing any unit, always use a separate isolation transformer for the chassis. Failure to use a separate isolation transformer may expose you to possible shock hazard, and may cause damage to servicing instruments.
8. Many electronic products use a polarized ac line cord (one wide pin on the plug). Defeating this safety feature may create a potential hazard to the servicer and the user. Extension cords which do not incorporate the polarizing feature should never be used.

Fire and Shock Hazard (Continued)

9. After reassembly of the unit, always perform an ac leakage test or resistance test from the line cord to all exposed metal parts of the cabinet. Also, check all metal control shafts (with knobs removed), antenna terminals, handles, screws, etc. to be sure the unit is safe to operate without danger of electrical shock.

* Broken line: 

Leakage Current Cold Check

1. Unplug the ac line cord and connect a jumper between the two prongs of the plug.
2. Turn on the power switch.
3. Measure the resistance value between the jumpered ac plug and all exposed cabinet parts of the receiver, such as screw heads, antennas, and control shafts. When the exposed metallic part has a return path to the chassis, the reading should be between 1 megohm and 5.2 megohms. When the exposed metal does not have a return path to the chassis, the reading must be infinity. Remove the jumper from the ac line cord.

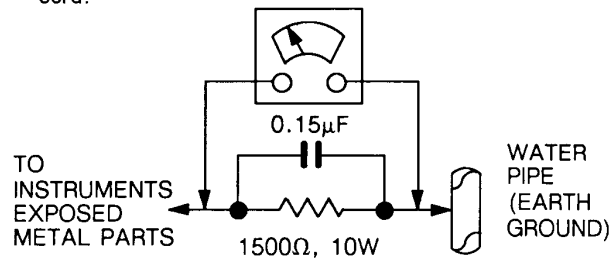

Leakage Current Hot Check

1. Do not use an isolation transformer for this test. Plug the completely reassembled unit directly into the ac outlet.
2. Connect a 1.5k, 10W resistor paralleled by a 0.15µF capacitor between each exposed metallic cabinet part and a good earth ground such as a water pipe, as shown above.
3. Use an ac voltmeter with at least 5000 ohms/volt sensitivity to measure the potential across the resistor.
4. The potential at any point should not exceed 0.75 volts. A leakage current tester may be used to make this test; leakage current must not exceed 0.5 milliamperes. If a measurement is outside of the specified limits, there is a possibility of shock hazard. The receiver should be repaired and rechecked before returning it to the customer.
5. Repeat the above procedure with the ac plug reversed. (Note: An ac adapter is necessary when a polarized plug is used. Do not defeat the polarizing feature of the plug.)

Parts Replacement

1. Many electrical and mechanical parts in Philips equipment have special safety related characteristics. These characteristics are often not evident from visual inspection nor can the protection afforded by them necessarily be obtained by using replacement components rated for higher voltage, wattage, etc. The use of a substitute part which does not have the same safety characteristics as the Philips recommended replacement part shown in this service manual may create shock, fire, or other hazards. Under no circumstances should the original design be modified or altered without written permission from Philips. Philips assumes no liability, express or implied, arising out of any unauthorized modification of design. Servicer assumes all liability.
2. All ICs and many other semiconductor parts are susceptible to electrostatic discharges (ESD). Careless handling during repair can reduce the life of the part drastically.

LASER NOTE:

DANGER - Invisible laser radiation when open. AVOID DIRECT EXPOSURE TO BEAM.

CAUTION - Use of controls or adjustments or performance of procedures other than those specified herein may result in hazardous radiation exposure.

CAUTION - The use of optical instruments with this product will increase eye hazard.

3. Directions for use

CONTROLS AND CONNECTIONS

DISPLAY

English

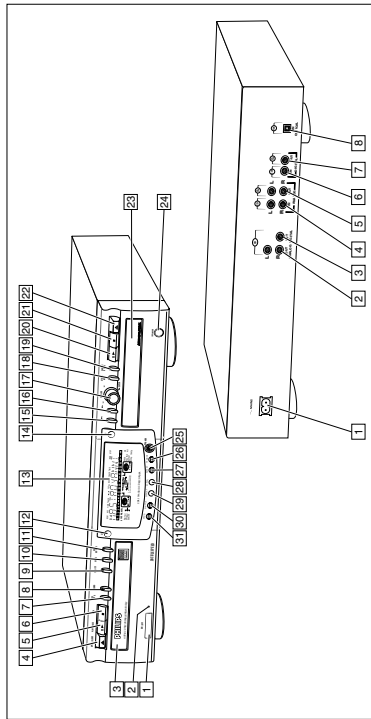

Controls on the front

- CD recorder**
 - 1 **ON/OFF** turns the CD recorder ON or OFF (if the recorder is in Standby mode, any key press will activate the CD recorder)
 - 2 Standby indicator
 - 3 Disc tray
 - 4 **OPEN/CLOSE ▲** opens/closes disc tray
 - 5 **PLAY/PAUSE ► II** starts play/interrupts play or recording
 - 6 **STOP ■** stops/clears a program
 - 7 **RECORD TYPE** selects recording modes
 - 8 **RECORD** starts recording, finalizing, erasing
 - 9 **FINALIZE** selects finalize mode
 - 10 **ERASE** selects erasing mode (disc or track)
 - 11 **EXT SOURCE** selects external input source
 - 12 **CDR** selects CD recorder deck
 - CD player**
 - 14 **CD** selects CD player deck display/keys
 - 20 **PLAY/PAUSE ► II** starts play/interrupts play
 - 21 **STOP ■** stops/clears a program
 - 22 **OPEN/CLOSE ▲** opens/closes disc tray
 - 23 Disc tray
 - General**
 - 13 Display information screen
 - 15 **◀ ▶** searches backward review mode
 - 16 **▶ ▶** searches forward review mode
 - 17 **◀ EASY JOC ▶** (rotate) previous/next track (Play and Program mode)
 - 18 **ENTER** (push) recording level control (recording)
 - 19 **STORE/MENU** selects settings (Menu on)
 - 20 **CANCEL/DELETE** plays selected tracks
 - 21 programs: track numbers
 - 22 Stores Menu settings
 - 23 enters Menu mode
 - 24 **IR sensor** deletes tracks from a program
 - 25 returns to a higher level in the menu
 - 26 **PHONES** receives signals from the remote control
 - 27 **DJ MODE** socket for headphones
 - 28 **REPEAT** separate play of CD recorder deck and CD player deck
 - 29 **SCROLL** repeats play (All, program or track)
 - 30 **DISPLAY** activates scrolling of text over the display (once)
 - 31 **SHUFFLE** selects display information, permanent text scrolling and time plays CDR(W) or program in random order
 - 32 **PROG(AM)** opens/closes program memory
- Note: Unless stated otherwise, all controls are on the front of the CD recorder. When provided on the remote control, you can also use the corresponding buttons, after selecting the CD recorder deck or CD player deck by pressing CDR or CD.*

English

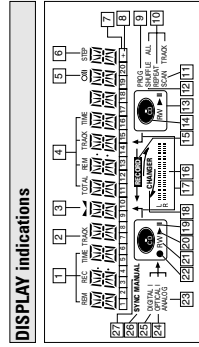

DISPLAY indications

- 1 **REM/REC TIME** remaining time/remaining recording time/recording time
- 2 **TRACK** track number
- 3 **▶ ◀** balance lights during balance adjustment
- 4 **TOTAL REM TRACK TIME** total or remaining time of disc or track
- 5 **ON** remote control active
- 6 **STEP** indicates the number of tracks in a program
- 7 **Track bar** indicates:
- tracks on a disc or in a program
- track in play
- disc or program contains more than 20 tracks
- flashes during programming/lights in program mode
- 8 **REPEAT TRACK/ALL** lights up when a track/complete disc (or program) is repeated
- 9 **lights up when the first 10 seconds of each track are played**
- 10 **SHUFFLE** CD player deck selected
- 11 **CD inserted (a pre-recorded CD or finalized CDR or CDRW disc)**
- 12 **lights during recording from the internal CD**
- 13 **L/R/II II** recording level bar. Indicates the audio signal level
- 14 **DJ mode selected**
- 15 **CHANGER** changer mode selected
- 16 **II** pause function active
- 17 **lights during play**
- 18 **(RW)** unformatted CDR(W) disc inserted
- 19 **lights during recording**
- 20 **ANALOG** analog input selected for external recording
- 21 **OPTICAL I** analog recording
- 22 **OPTICAL I** optical input I selected for external recording
- 23 **DIGITAL I** digital input I selected for external recording
- 24 **SYNC** automatic or synchronised start of external recording
- 25 **MANUAL** manual operation of external recording

Connections at the back

- 1 Connection to mains
- 2 **ANALOG OUT** connects CD player deck to the line input of an amplifier (left and right)
- 3 **DIGITAL OUT CD** connects CD player deck to the digital coaxial input of e.g. amplifier or recording device
- 4 **ANALOG IN** connects to the line output of an amplifier (left and right)
- 5 **ANALOG OUT CDR & CD** connects to the line input of an amplifier (left and right)
- 6 **DIGITAL IN** connects to the digital coaxial output of an external CD player
- 7 **DIGITAL OUT CDR & CD** connects to the digital coaxial input of e.g. amplifier or recording device
- 8 **OPTICAL IN** connects to the digital optical output of an external CD player

CONTROLS AND CONNECTIONS

DISPLAY

DISPLAY

DISPLAY messages

Messages, as listed and explained here, may appear on the display for your guidance.

General

REPAIRING.....reading disc information
 OPEN.....during tray opening
 CLOSE.....during tray closing
 NO DISC.....no disc inserted, disc unreadable or disc inserted upside down
 PROG FULL.....program full
 INSERT DISC.....insert disc or insert disc in correct way
 WRONG DISC/.....inserted disc is not an audio CD
 USE AUDIO CD.....unfinalized CDR(W) disc
 UNFINALIZED.....unfinalized disc
 MEMORY x%o/v.....indicates the amount of text memory used for unfinalized discs

Recording

PAUSE.....when STOP ■ is pressed during recording
 - when STOP ■ is pressed during recording the first 4 seconds of a track
 UPDATE.....updating disc contents
 DISC FULL.....no more recording possible
 DIGITAL 1.....digital coaxial input 1 selected
 DIGITAL 2.....digital optical input selected
 ANALOG.....analog input selected
 COPY PROTECT.....no digital recording can be made of the external source
 NOT FINALIZED.....when opening the tray with an unfinalized disc inserted
 RECORDY FAST.....high speed recording selected
 REC LISTEN.....listen speed recording selected
 MAKE CD.....high speed recording of a complete disc; and Auto Finalize function selected
 REC EXT DISC.....synchronised start of recording from external source selected
 REC EXT MNR.....manual start of recording from external source selected
 -x% o/v.....level is being adjusted
 INDEX NOT FIT.....time left on CDR(W) disc is not enough for proposed recording
 ANALOG REC.....copy prohibited track found during recording; track will be copied analog (Copy Protection Regulations)
 ERASE TRACK.....when erasing one or more tracks
 ERASE DISC.....when erasing a disc
 FINALIZE CD.....when finalizing a disc
 FINALIZED.....when trying to finalize an already finalized disc
 CHECK INPUT.....when RECORD is pressed while no digital source is detected
 x% x% ERASE.....time countdown when erasing a track or a disc

English

DISPLAY

MENU messages - See Menu mode

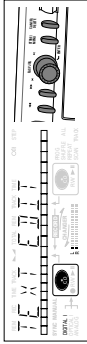

Menu messages

NO TRACKS.....when attempting to edit text for a disc which has no tracks
 TEXT EDIT.....when entering Text Edit mode
 ALBUM ARTIST.....when editing or erasing an artist name
 ALBUM TITLE.....when editing or erasing a title
 ARTIST TR x.....when editing or erasing an artist name per track
 TITLE TR x.....when editing or erasing a title per track
 TEXT ERASE.....when entering Text Erase mode
 ALL TEXT.....when entering All Text mode
 ERASE OK.....when confirmation for erasing has to be given with ENTER key
 ERASE ALL OK.....when confirmation for erasing has to be given with ENTER key
 ERASE MEMORY.....when waiting for confirmation when erasing a disc
 MEMORY VIEW.....when selecting text review per unfinalized disc in memory
 MEMORY EMPTY.....when REVIEW is selected while no text is in memory
 AUTO TRACK.....when selecting auto track increment ON or OFF
 ON.....auto track increment on
 SET BALANCE.....auto track increment off
 NO TEXT.....when selecting BALANCE no text stored for disc

Connections general

For playback on the CD recorder (and/or CD player deck) the following outputs are present:

- Digital coaxial output (CD & CDR);
 - Analog output (CD & CDR).
- We advise you to connect these to the TAPE or CDR input on your amplifier.

For external recording the following inputs are present:

- Digital optical input;
- Digital coaxial input;
- Analog input.

For playback of CD player deck separately (DJ mode) from the CD recorder the following outputs are present:

- Digital coaxial output (CD);
- Analog output (CD).

We advise you to connect these to the CD input on your amplifier.

The connections you make will depend upon the possibilities your audio equipment offers. Please refer to the user manuals for your other audio equipment first.

Digital recordings (optical or coaxial) give the best performance in audio and usability (e.g. auto-track).

(The digital optical connection is less sensitive to external disturbances).

If your equipment does not offer digital connections, the high quality Analog-Digital-Converter of your CD recorder will ensure very good audio performance when recordings are made from the analog input.

Playback via the digital coaxial output of the CD recorder gives the best audio performance.

If your equipment does not offer digital connections, the high quality Digital-Analog-Converter of the CD recorder ensures a very good sound quality via the analog output.

We advise you to always establish both digital and analog connections. In this way you can always make analog recordings when digital recording is not possible.

We have described the most common ways of connecting the CD recorder. If you still have difficulties with the connections you can always contact the Philips Consumer Service desk in your country.

English

INSTALLATION

INSTALLATION

English

Analog connections CD recorder & CD player

This connection must be made for playback on the CD recorder deck as well as the CD player deck (cable ②). Cable ① is only required if you want to make recordings from an external analog source.

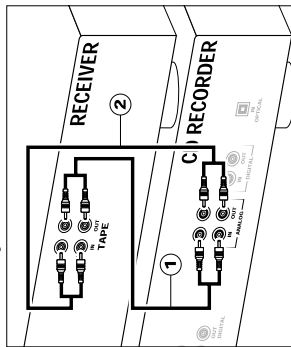

Use the audio cables supplied. Connect the red plugs to the R sockets, and the white plugs to the L sockets.

- 1 For recording, connect cable ① between the ANALOG IN-sockets on the CD recorder and the CDR LINE- or TAPE OUT-sockets of an amplifier.

Note: For recording directly from a CD player, the analog input of the CD recorder should be connected to the analog output of the CD player.

- 2 For playback, connect cable ② between the ANALOG OUT-sockets on the CD recorder and the input sockets of an amplifier e.g. TAPE IN, CDR or AUX.

Note: Never use the PHONO input.

Analog connections CD player deck

This connection is only required if you want to playback on the CD player deck separately from the CD recorder deck. This will be the case in DJ-mode.

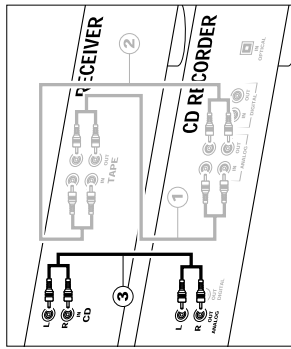

- 1 For separate playback on the CD player deck, connect a third cable ③ (not supplied) between the ANALOG OUT-sockets of the CD recorder and the input sockets of an amplifier e.g. CD, or AUX. (Connect the red plugs to the R sockets, and the white plugs to the L socket.)

Note:

- Never use the PHONO input.

- Your CD recorder/player is equipped with a digital coaxial output for the CD player deck. This output can be used for digital playback.

INSTALLATION

English

Digital optical connections CD recorder

This connection is only required if you want to make recordings from an external CD player with a digital optical output.

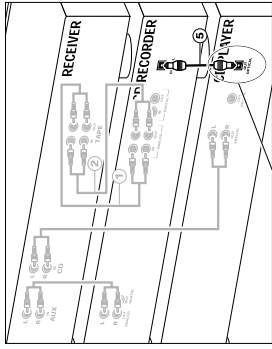

Use the digital coaxial cable supplied.

- 1 For external recording, connect the cable ④ between the DIGITAL IN-socket on the CD recorder and the DIGITAL OUT-socket of an external CD player.

Note: Your CD recorder is equipped with a digital coaxial output (common output for CD recorder & CD player deck). This output can be used for digital playback.

When connecting the Digital Optical cable, make sure it is fully inserted until there is a click.

- 1 Remove the dust caps from the digital optical connection. (We recommend you save the cap.)

- 2 For external recording, connect a fibre-optic cable ⑤ between the digital optical input of the CD recorder and the digital-optical output of an external CD player.

Note: For playback, the digital coaxial outputs or analog outputs of the CD Player and CD recorder should be connected to an amplifier.

INSTALLATION

English

Power supply

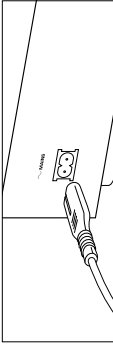

- 1 Plug the power cord supplied into the MANS connector on the CD recorder, then into a mains socket.
- 2 Press ON/OFF. → The CD recorder will switch on.
- 3 The recorder switches automatically to active mode.

Note: When the CD recorder is in the 'OFF' position, it is still consuming some power. If you wish to disconnect your player completely from the mains, withdraw the plug from the AC outlet.

Setup recommendations

- Place the CD recorder on a solid, vibration free surface.
 - Do not place the CD recorder near a source of heat or in direct sunlight.
 - Do not use the CD recorder under extremely damp conditions.
 - If the CD recorder is placed in a cabinet, make sure that a 2.5 cm space remains free on all sides of the CD recorder for proper ventilation.
- Important:**
- Do not put the CD recorder on top of other equipment that heats up the CD recorder (e.g. receiver or amplifier).

Inserting batteries in the remote control

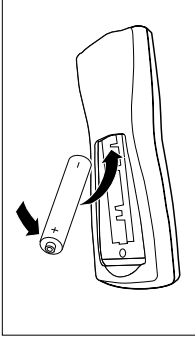

- 1 Open the battery compartment cover.
- 2 Insert 2 batteries ("AA", LR-6 or UM-3, as supplied) as shown.
- 3 Replace the cover.

Note: We recommend you use 2 batteries of the same type and condition.

Batteries contain chemical substances, so they should be disposed of properly.

REMOTE CONTROL

English

Inserting discs

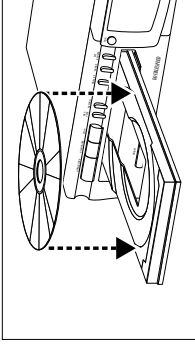

- 1 Press OPEN/CLOSE to open the disc tray. → OPEN lights up.
- 2 Insert a CD, CDR or CDRW in the appropriate recess in the tray, label side up.

- 3 Press OPEN/CLOSE to close the tray (see also Playing a CD). → CLOSE lights up, followed by READING and the display will show the type of disc you inserted.

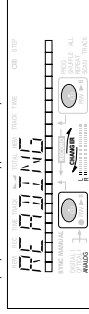

- If you insert a blank or partly-recorded CDR or unformatted CDRW, the CD recorder will calibrate the disc for optimum recording. During this process the display will first show INITIALIZING and then the number of audio tracks. Calibration can take up to 25 seconds.

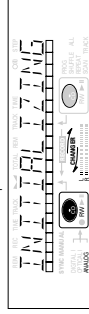

- If a CDRW is finalized it will show CD on the display.
- If CD-text is available the TITLE/ARTIST will scroll by.



Note:

- Only Audio CDs will be accepted. If a non-audio disc is inserted, the display shows PROTECT DISC/USE RUBIO CD.
- Reading an unformatted disc in the CD recorder deck could take approximately 1 minute.
- For recording it is important that the blank disc is completely free from dust particles or scratches. (see maintenance).

Remote control commands

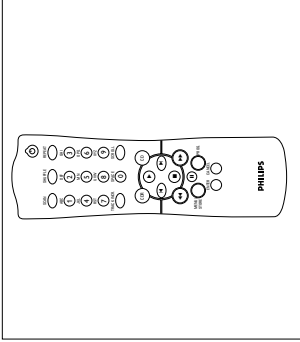

- STANDBY** ○ switches to Standby/On
- SCAN** plays the first 10 seconds of each track
- SHUFFLE** plays CDRW or program in random order
- REPEAT** repeat play
- Number/alphabet keys 0 - 9** selects a track by number
- TRACK INCR (ement)** increases track numbers during recording
- SPACE** inserts a space character during recording
- SCROLL** activates scrolling of text over the display
- CDR** selects CD recorder deck
- CD** selects CD player deck
- ▲ starts CDRW play
- ▼ previous track (Play and Program mode)
- ▶ cursor control in Menu/Prog. review mode
- ▶ next track (Play and Program mode)
- cursor control in Menu/Prog. review mode
- stops CDRW) and clears a program
- ◀ searches backward
- ▶ searches forward
- || interrupt CDRW play/recording
- MENU/STORE** enters Menu mode
- stores Menu settings
- PROG.(ram)** opens/closes program memory
- ENTER** selects settings in Menu mode
- programs track numbers
- starts playback of selected track
- CANCEL** deletes tracks from a program
- deletes text in Menu mode
- returns to a higher level in the menu

RECORDING

English

Remarks about recording

- You will soon discover how easy it is to make your own CDs. Nevertheless, it is advisable to use a CDRW disc for your first try. We will describe:
 - Recording from internal CD player deck: high speed or listen mode.
 - Recording from an external CD player deck: synchronized start with CD player or manual start. (analog or digital).
- If the disc is a CDRW and is already finalized you must unfinalize it first.
- The recording procedure is the same for CDRs and CDRWs.
- If the disc already contains recordings, the CD recorder will automatically search for the end of the last track, so that recording can start from there.
- CD text can be added to a recording in Stop mode and during recording.
- CD text can not be recorded from an external CD player. (Text information is not available on the output of the CD player.)
- The CD recorder deck is able to record CD text from the internal CD player deck (if not subjected to copy protection). This may take up to 2 minutes.
- There must be at least 7 seconds of recording time left on the disc, otherwise you will not be able to enter record standby mode. **DISC FULL**, then lights up.
- If the display indicates **COPY PROTECT**, no digital recording can be made of the source material. Recording will not start.
- The **Serial Copy Management System (SCMS)** only allows digital recording under specific conditions:
 - This means that it is not possible to make a digital copy from a digital copy.
 - Analog recording is always possible!
 - The number of recordings from the original is unlimited.
- A maximum of 99 tracks can be recorded on a disc. Minimum allowable track length is 4 seconds.
- Recordings from DAT or DCC players will not always stop automatically.

Recording modes

Your recorder offers several recording modes:

For recording from internal CD-deck:

- **RECORD FAST** (high speed digital recording) - fast recording of a disc or programmed tracks.
 - **REC LISTEN** (normal speed digital recording) - listening to a recording while making it.
 - **MAKE CD** (high speed digital recording and auto-finalize) - fast recording of a disc or programmed tracks. Recording will be finalized automatically.
- Warning:** No more recording possible after finalizing CDR disc!

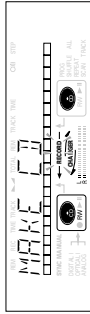

For recording from external sources:

- **REC EXT DISC** (automatic start of recording) - to make an automatic recording of an external source simply by starting the source.
- **REC EXT MAN** (manual start of recording) - to start a manual recording from an external source.

Some remarks on recording:

- During high speed recording, the original recording quality will be maintained.
 - When Auto track is on (default setting), track numbers will automatically be increased during recording.
 - By programming tracks first, a compilation can be recorded.
 - If a finalized CD recordable disc is inserted in the CD recorder, **FINALIZED CD** will be displayed when REC TYPE is pressed. Recording is not possible.
 - If a finalized CD rewritable disc is inserted in the CD recorder, **UNFINALIZED** and **PRESS ENTER** will be displayed when the REC TYPE is pressed. If ENTER is pressed, the disc will be unfinalized.
- Note: If during recording **FINAL DIS REC** appears, the track will be recorded as analog, at normal speed. All other tracks will be copied normally (at double speed).*

Important:

If you want to play the recorded CDR disc on any regular CD player, it must first be finalized. See finalizing discs.

Finalized CDRW discs play only on CDRW compatible CD players.

For recording from CD changers always use **REC EXT DISC**.

RECORDING

English

High speed recording from internal CD player

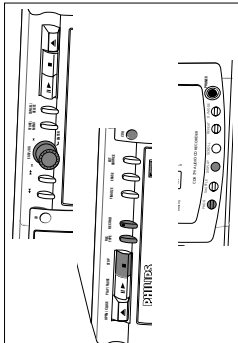

During high speed recording the sound is not audible.

Preparing for high speed recording

1 Make sure that the recording disc is absolutely free of scratches and dust particles.

2 Press **REC TYPE** to choose the type of recording:

- To select **RECORD FAST** - if you wish to make a fast recording of a disc or programmed tracks, three times to select **MAKE CD** if you wish to make a fast recording of a disc or programmed tracks and to automatically finalize the recording.
- The display first shows the selection.

The **REC** label starts blinking. After 3 seconds the display shows the remaining CDRW recording time on the left and total time of source on the right. Every 2 seconds **PRESS RECORD** is displayed.) The left selection indicator is lit.

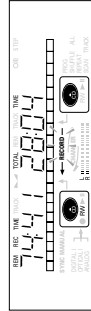
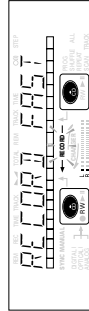

- If **DISC NOT FIT** appears on the display, there is not enough recording space left on the CDRW disc. You can press **RECORD**; only complete tracks that still fit on the CDRW will be recorded.
- You can press **PROG** to select one or more tracks for recording (see programming):
 - rotate the **EASY/JOG/ENTER** key to the required track number, then press the key (or **ENTER** on the remote control)
 - or
 - directly select the track number via the 10-keypad on the remote control then press the **ENTER** key to confirm your selection and go to the next step.

Start high speed recording

1 Press **RECORD** to start recording.

→ **PREPARE** lights up. The display shows the total remaining time for the selected recording. High speed recording starts. → **RECORD** - lights continuously.

- To check the track number and track time, press **DISPLAY**. This can be done during recording.

- Recording will stop automatically.

*Note: Copy prohibited tracks will be copied analog. **FINAL DIS REC** is displayed.*

2 To stop recording manually, press **STOP**.

→ **UP/JRITE** lights up. → **RECORD** - goes out and recording stops. (Minimal track length must be 4 seconds otherwise silence will be added to the track)

- If **STOP** was pressed within 3 seconds after **RECORD**, no recording will take place.

After recording, the display shows **UP/JRITE** for several seconds. The total time indications can differ slightly. However, no music information is lost.

Note: In this Recording mode, the Pause function is not operative.

Important:

If you want to play the recorded CDR disc on any regular CD player, it must first be finalized. See finalizing discs.

Finalized CDRW discs play only on CDRW compatible CD players.

RECORDING

English

Listen mode recording from internal CD player

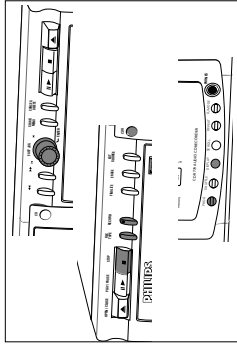

During Listen mode recording you listen to the recording while you are making it.

Preparing for Listen mode recording

1 Make sure that the recording disc is absolutely free of scratches and dust particles.

2 For recording, press REC TYPE twice:

- The display first shows the selection. The → RECORD – label starts blinking. After 3 seconds the display shows the remaining CDR(W) recording time on the left and total time of source on the right. (every 2 seconds PRESS RECORD is displayed) The left selection indicator is lit.

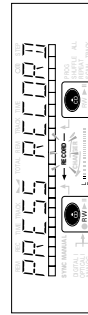
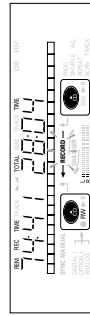
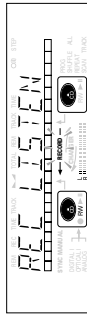

- If JONES HGT FET appears on the display, there is not enough recording space left on the CDR(W) disc. You can press RECORD: only complete tracks that still fit on the CDR(W) will be recorded.

or
You can press PROG to select one or more tracks for recording (see programming):
- rotate the EASY JOG/ENTER key to the required track number, then press the key for ENTER on the remote control)

18

RECORDING

English

- Display shows REC EKT HRT followed by HRTT. After a few seconds PRESS RECORD is followed by the remaining time and track number appear on the display.



3 Play the source first to set the optimal recording level on the CD recorder.

4 Play the source first to set the optimal recording level on the CD recorder.

5 Rotate the EASY JOG/ENTER key until, on the Record/Play Level bar, all the blue segments are alight, but the red segments do not light continuously during the loudest passages.

→ Display shows → REC (Decibel, e.g. → 33).

6 Stop the source.

Start manual recording

- 1 To start recording, press RECORD on the CD recorder and immediately start the source (from Pause or Stop-mode). → lights continuously. The track number and recording time left appear on the display.

- If CHECK INPUT message also flashes, the digital connection is incorrect.

- To record a 3-second silence at the start of a track, press PAUSE on the CD recorder before starting the source.

- To check the total remaining recording time, press DISPLAY on the CD recorder. (This can also be done during the recording.)

2 To stop recording, press STOP on the CD recorder.

- UP/BYTE lights up and → goes out.

- If STOP was pressed within 3 seconds after RECORD, no recording will take place.

- To interrupt recording, press PAUSE on the CD recorder. → starts to flash. Press PAUSE again to restart recording. (A new track will always be made.)

After recording the display will show UP/BYTE for several seconds.

Note: Recordings made analogously will stop after 20 seconds silence. With AUTO TRACK OFF, the auto stop mode is disabled.

Important:

If you want to play the recorded CDR disc on any regular CD player, it must first be finalized. See finalizing discs.

Finalized CDRW discs play only on CDRW compatible CD players.

For recording from CD changers always use REC EKT.

19

Manual recording from external CD player

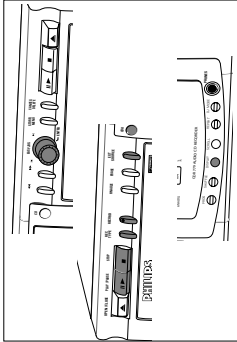

Important:
- Recording from CD-changers should always be started in the Auto-Start mode.
- Only make analog recordings when digital recording is not possible.

Preparing for manual recording

1 Make sure the disc is absolutely free of scratches and dust particles.

2 Press EXTERNAL SOURCE repeatedly until (depending on the connection used):

- DIGITAL I, OPTICAL or ANALOG lights up and DIGITAL I, OPTICAL or ANALOG appears on the display.



- When Auto Track is On (default setting), track numbers will automatically be increased during recording.

- To switch off the Auto Track function you have to enter Menu mode.

- If you wish to increase track numbers manually, press TRACK INCREMENT on the remote control. For further instructions see Menu mode.

ON (Auto): The track increments are automatically taken over from the digital source material or after 2,7 seconds silence during analog recording.

OFF (Manual): While recording track numbers can be incremented manually by pressing TRACK INCREMENT on the remote control. (Minimum track length is 4 sec.) (This can also be done in Auto track ON mode.)

- Track numbers cannot be changed after recording.

Note: Auto track works only with Consumer Sources with a digital output signal according to the IEC 959 (consumer part) audio standard.

3 With the recorder stopped, press REC TYPE five times to enter the Manual Record standby mode.

RECORDING

English

Autostart recording from external CD player CD-SYNC

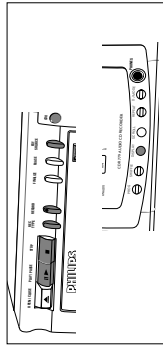

The CD-SYNC feature enables you to make fast and easy recordings of a CD. Track increments are automatically detected from the source material. Track increments cannot be added manually. In analog source material a silence of 2.7 seconds or more is automatically detected as a track increment.

Preparing for autostart recording

- 1 Make sure the disc is absolutely free of scratches and dust particles.
- 2 Press EXTERNAL SOURCE repeatedly until (depending on the digital connection used):
 - DIGITAL or OPTICAL or ANALOG lights up and DIGITAL, OPTICAL or ANALOG appears on the display.

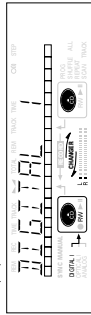

- 3 With the CD recorder stopped, (press REC TYPE) four times:
 - if you wish to record a complete disc or program,
 - and SYNC start to flash and the display shows REC EXT, DISC and HRTIT followed by the track number, the total remaining time and START SOURCE.

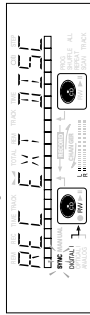

- If input label (DIGITAL I) flashes, the digital connection is incorrect.

Start autostart recording

- 1 To start recording, (press PLAY) on the selected source.
 - The CD recorder automatically starts to record and and SYNC lights continuously. The track number and track time appear on the display.

- If, however, you start the source during a track, CD-SYNC recording starts at the beginning of the next track or after 2.7 seconds of silence in analog recordings.
- To check the remaining recording time on the CDR(W), press DISPLAY. (This can also be done during recording.)
- The EASY JOG/ENTER key can be used to adjust the recording level.
- The recorder stops automatically.

2 To stop recording manually, press STOP on the CD recorder.

- UP/BYTE lights up and SYNC and → go out.
- If STOP was pressed within 3 seconds after pressing PLAY, no recording will take place.
- To interrupt recording, press PAUSE on the CD recorder.
- starts to flash. (Autostart recording is disabled.) To resume, press RECORD on the CD recorder.

After recording the display will show UP/BYTE for several seconds.

Note: Auto track is always active.

Important:
If you want to play the recorded CDR disc on any regular CD player, it must first be finalized. See finalizing discs.

Finalized CDRW discs play only on CDRW compatible CD players.

For recording from CD changers always use REC EXT DISC.

RECORDING

English

Unfinalizing CDRW discs

For CDRW discs only.
If you want to make more recordings (or erasures of tracks) on a finalized disc: you must unfinalize it first. The Table of Contents (TOC) will be removed. (This is not possible for CDR discs.) To unfinalize:

- 1 With the CD recorder stopped, press REC TYPE or ERASE. → UNFINALIZE and PRESS ENTER will appear on the display.

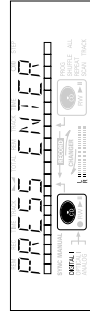

- 2 Press JOG (ENTER).
 - The disc will now be unfinalized and can be recorded on again and the Recording or Erasure mode is entered.



- 3 You can now start recording or erasing. If no further recording or erasure is required press STOP.

Note:

- Unfinalizing will take approximately 1 minute 30 seconds.
- When unfinalizing a CDRW disc with text on it available, this text will be transferred to the CD recorder memory. It may occur that the text memory is full. The message RECOR-3 FULL/FINALIZE CD will be displayed.
- To empty the recorder's text memory you have to erase text from it. This can be done in two ways:

- 1) Finalize one or more unfinalized discs for which CD text is available.
- 2) Delete text of unfinalized discs with the 'memory view' option in the Menu mode.

Finalizing CDR & CDRW discs

During finalizing the Table of Contents (TOC) is written to the disc.

- Finalizing is a simple procedure, necessary to:
 - be able to play recordings on a CD PLAYER,
 - avoid further unwanted recordings on a disc,
 - write CD text on a CDR(W).

Auto finalizing

Auto finalizing is possible when using the MAKE CD recording function.

Manual finalizing

- 1 Make sure the disc (in the CD recorder deck) is absolutely free of scratches and dust particles.

- 2 With the recorder stopped press FINALIZE.
 - The display shows FINALIZE CD and PRESS RECORD.

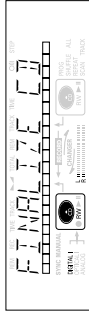

3 Press RECORD.

- XX:XX F:INFL and the approximate finalization time appears on the display.
- The display counts down through the finalization.
- On completion, the total number of tracks and the total time recorded appears on the display.
- For CDR(W) changes to on display.

Finalizing will take at least 2 - 4 minutes.

Note:

- During finalization, the CD recorder accepts no operating commands.
- When a CDR is finalized no more recordings can be added.

RECORDING

English

Erasing CDRW discs

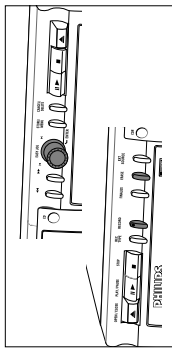

For uninitialized CDRW discs only.

You can erase:

- Tracks can only be erased from the end.

- With the EASY JOG you can erase more tracks.

Note: It is not possible to erase tracks within the sequence.

- It is also possible to erase the entire disc: at once.

To erase one or more tracks from the end:

- 1 Press ERASE once.
 - The display shows the number of tracks and their total playing time. **ERASE TRACK** and **PRESS RECORD** lights up.
- If the disc is finalized, **CD** appears on the display after inserting a CDRW in the recorder. The recorder will ask you to confirm unfinalizing first. Confirm by pressing the EASY JOG/ENTER key or ENTER on the remote control.

- 2 Select the track(s) you wish to erase by turning the EASY JOG/ENTER key to the left.
 - The selected track numbers start blinking on the track bar.

- The display shows the remaining time after erasing the selected track(s), the shown track will also be included in the erasure of tracks.

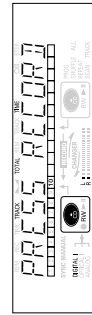
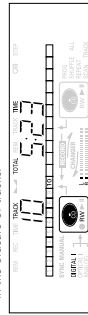

- 3 Press RECORD.
 - The display shows the total countdown time and **ERASE**.
 - After the selected track(s) have erased, the display shows the remaining tracks and their total playing time.

22

PLAYING

English

Playing CDs on Deck 1 and/or Deck 2 (DJ mode)

With this double deck it is possible to play the CD recorder deck and/or the CD player deck individually (at the same time). In this case the extra CD output must also be connected to an amplifier.

- 1 Select DJ mode using the DJ MODE key.
 - **DJ MODE** appears on the display and **↑** lights up.



- 2 On the deck you want to play, press **PLAY/PAUSE** **▶▶** to start CD play.
 - **▶▶** lights up and the track number and track time of the track in play appear on the display.

- You can also play the two decks at the same time. By pressing the CDR key or the CD key you can choose the deck you want to listen to.

- Press **DISPLAY** once, twice or three times to see:
 - remaining track time, total remaining time, permanent text information (see Menu mode).

- To interrupt play temporarily, press **PLAY/PAUSE** **▶▶** again.
 - **▶▶** lights on the display.

- To continue play, press **PLAY/PAUSE** **▶▶** again.

- 3 To stop play, press **STOP** **■**.
 - The number of tracks and the total playing time appear on the display. If you want to see this information about the other deck, press **CDH** or **CD**.

Intro Scan

- 1 In stop mode press **SCAN** on the remote control.
- 2 The first 10 seconds of each track on the CD (or program if set) are played.
- 3 Press **SCAN** again to return to normal CD play mode.

Play a 2-disc changer (Changer mode)

Your CD recorder is able to play the two decks sequentially (CHANGER mode). This is the default setting.

- 1 Select Changer mode using the DJ MODE key.
 - **CHANGER MODE** appears on the display and **CHANGER** lights up.



- 2 On the deck you want to play, press **PLAY/PAUSE** **▶▶** to start CD play.
 - **▶▶** lights up, the track number and track time of the track in play appear on the display.
 - After playing the first disc, the second disc will automatically be played.

- Press **DISPLAY** once, twice or three times to see:
 - remaining track time, total remaining time, permanent text information (see Menu mode).

- To interrupt play temporarily, press **PLAY/PAUSE** **▶▶** again.
 - **▶▶** lights on the display.

- To continue play, press **PLAY/PAUSE** **▶▶** again.

- 3 To stop play, press **STOP** **■**.
 - The number of tracks and the total playing time appear on the display.

- If you want to see the information about the other deck, press the **CDH** key or the **CD** key in the display frame.

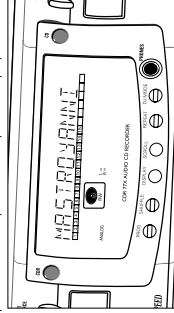

23

PLAYING

English

Selecting a track

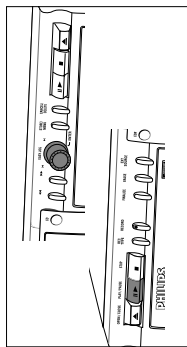

Selecting a track during play

- 1 Turn the EASY JOG/ENTER key until the required track number appears on the display.
 - Play skips to the beginning of the selected track.
- or
- Select CDR or CD on the remote control and key in the required track number using the numerical keys on the remote control. For 2-digit track numbers, press the keys in rapid succession. For tracks on the other disc, first press CD or CDR as applicable.
 - Play skips to the beginning of the selected track.
- or
- Press ◀ or ▶ on the remote control one or more times.
 - Play skips to the beginning of the present, previous or subsequent tracks, including tracks on the disc in the other deck. (Changer mode only)

Selecting a track when CD play is stopped

- 1 Turn the EASY JOG/ENTER key until the required track number appears on the display.
 - 2 Press EASY JOG/ENTER or ENTER on the remote control to confirm or press PLAY/PAUSE ▶ II to start playing.
- or
- 1 Select CDR or CD on the remote control and key in the required track number using the numerical keys. For 2-digit track numbers, press the keys in rapid succession. Play starts.
 - or
 - 1 Briefly press ◀ or ▶ one or more times.
- 2 Start playback by pressing PLAY/PAUSE ▶ II. EASY JOG/ENTER or ENTER on the remote control.

Search

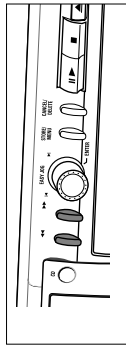

- 1 Hold down ◀◀ or ▶▶ (in play mode).
 - The player first searches backwards or forwards at 10 times normal speed with sound at low volume, then goes to 50 times normal speed with sound muted.
- 2 Release the button at the desired passage.
 - Play starts at the desired passage.

Note: During Shuffle, Repeat, Track or Programmed play, search is restricted to within the track being played at the time.

PLAYING

English

Repeat CD, track or program

- 1 Press REPEAT one or more times during CD play.
 - When REPEAT TRACK lights up, the current track plays repeatedly. When REPEAT ALL lights up, the disc or program plays repeatedly.

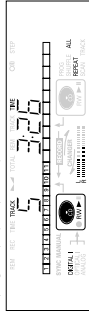

- 2 To return to normal play, press REPEAT one or more times until:
 - the REPEAT label disappears from the display.

Note:

- You can use shuffle in combination with REPEAT ALL or programmed play of the 2-disc changer.
- REPEAT is also cleared if you open the disc tray.

Shuffle (random order) play

- Only in Changer mode.
- 1 Select Changer mode, if necessary, using the DJ MODE key.
 - 2 Press SHUFFLE before or during CD play to start shuffle play.
 - The tracks on the CD (or program if set) play in random order.
 - 3 Press SHUFFLE again to disable the Shuffle mode.
 - CD recorder goes to Stop mode.

Note: Shuffle is also cleared if you open the disc tray.

PROGRAMMING

English

Remarks about programming

- You can program up to 99 tracks to play in any desired sequence.
- Tracks can be programmed more than once, but each time counts as a track. (STEP)
- A program for playback can be made from both the disc in the recorder deck and the disc in the player deck. A program for recording can only be made from the disc in the player deck.

Programming for playback

- Select Changer mode or DJ mode using the DJ MODE key.
 - CHANGER MODE or DJ MODE appears on the display.
- Press CDR or CD to select the required deck.
 - Selected key lights up.

- Press PROGRAM to enter Program mode.
 - PROG flashes and PROGRAM followed by track information appears on the display.

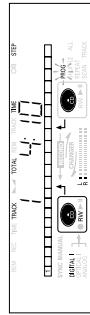
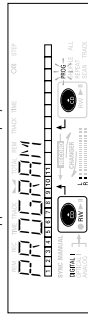

- Select the required track numbers by turning the EASY JOG/ENTER key left or right and store by pressing ENTER.
 - The track number and program step will be shown on the display.

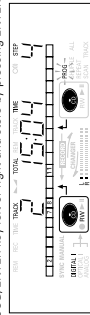

or:

- Key in a track number with the number keys on the remote control and press ENTER to confirm. For 2-digit numbers, press the keys in rapid succession.
 - The track will be stored in the program.
- The track number, total program time and the number of programmed tracks (STEP) are displayed.
- Repeat step 4 for all tracks to be programmed.
- Press STOP or PROGRAM to end programming.
 - PROG lights continuously.
- Press PLAY/PAUSE ► II to start programmed play.

26

English

MENU MODE

Remarks about Menu mode

- In Menu mode you will have access to a number of features which are not available via the regular keys (on the deck's front and the remote control).
 - The TEXT submenus (A-B) allow you to give names to discs and tracks. The disc and track names will be displayed during playback.
 - In the RECORDING submenus (D-E) you can set Auto Track and Balance.
 - All settings (except Balance) made in Menu mode will be stored in the deck's memory and can be called up and changed at any time.

General operation of Menu

Menu active in Recording or Stop mode.

- When using the remote control select first CDR.
- Press STORE/MENU on the deck or the remote control to enter Menu mode.
 - TEXT EDIT appears on the display.
- Rotate EASY JOG/ENTER to select the required submenu.
- Press EASY JOG/ENTER to confirm selections.
- Rotate EASY JOG/ENTER to select options in the submenus.
- Press EASY JOG/ENTER to confirm selections.
- Press STORE/MENU to store settings and return to the submenu.
- Press STOP to store settings and exit Menu mode.

Note: Track can only be edited for uninitialized discs. (Finalized CDRW discs must be uninitialized first.)

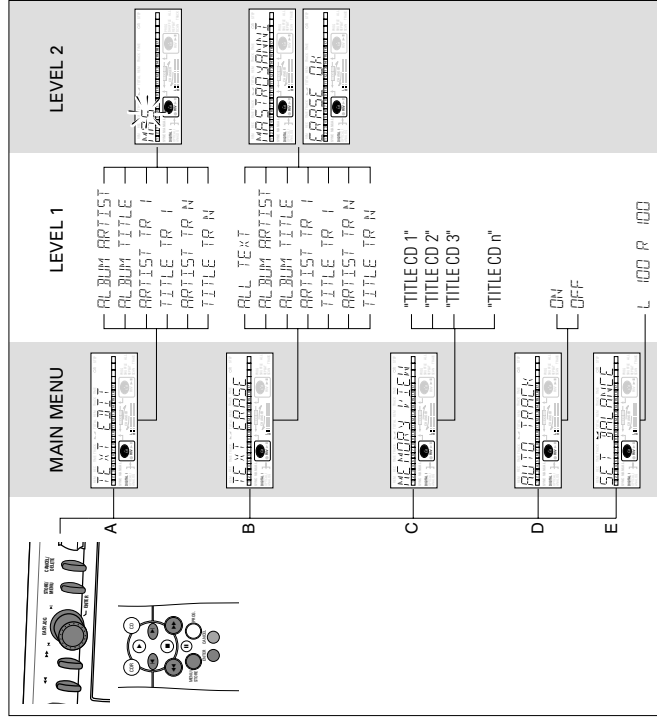

27

MENU MODE/CD TEXT

English

A. Text input/text edit

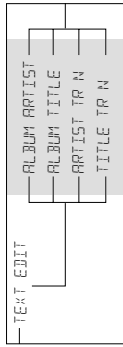

CD Text can be added to a recording or changed. This can be done in Stop mode or during recording.

Text will be stored in the recorder memory and can be edited until the CDR is finalized. Text on a (unfinalized) CDRW can be edited at any time.

- 1 Press STORE/MENU.
→ TEXT EDIT appears on the display.
- 2 Press EASY JOG/ENTER to confirm.
→ ALBUM ARTIST appears on the display.
- 3 Rotate EASY JOG/ENTER to select the required option in the submenu: ALBUM ARTIST, ALBUM TITLE, ARTIST TR N, TITLE TR N, etc.
- 4 Press EASY JOG/ENTER to confirm.
→ The first character space appears on the display.
- 5 Select the characters by rotating the EASY JOG/ENTER key or by pressing the corresponding numeric/alphabet key on the remote control.
- 6 Press EASY JOG/ENTER to store each character and move to the next cursor position.

- With the ← → keys you can move to a required cursor position.
- With the CANCEL key you can delete a character.

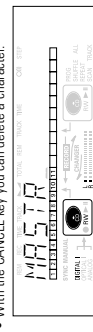

- 7 Press STORE/MENU to store a name you have entered and return to the submenu resume at 3 or STOP ■ to exit.

Note:
- A maximum of 60 characters can be stored per item.
- By pressing the EASY JOG/ENTER key or ENTER on the remote control without selecting a character first, you can insert a space between characters.
- When an artist's name has been stored for a certain track, the name will automatically be copied for the next track. The name can be confirmed by pressing STORE/MENU or a new name can be entered as described above.

MENU MODE/CD TEXT

English

C. Reviewing CD Text in memory/memory view

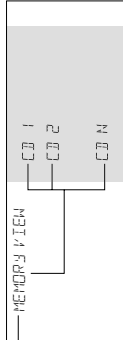

Note:
- If there are no discs in the memory, the message MEMORY EMPTY appears on the display.
- When the text memory of your CD recorder is full, the message MEMORY FULL will appear, followed by FINALIZE CD. If you want to add a CD to the list of discs for which text is stored, you have to erase a disc from this list or finalize another disc. ("for which text is stored")
- MEMORY FULL/FINALIZE CD may also appear when unfinalizing a CDRW disc for which text was stored (see "Unfinalizing a CDRW disc"). The same action(s) should be taken in order to obtain memory space.

CD Text is stored in the recorders memory. When a CDR(W) will be finalized the CD Text will be written on the disc, and removed from the recorders memory. With the MEMORY VIEW function one can view/delete the CD Text in the recorders memory per unfinalized disc. The amount of memory used is displayed each time the tray opens with an unfinalized CDR(W) inserted. (e.g. MEMORY 90%, α)

- 1 Press STORE/MENU.
→ TEXT EDIT appears on the display.
- 2 Rotate the EASY JOG/ENTER key to select the MEMORY VIEW submenu.
→ MEMORY VIEW appears on the display.
- 3 Press EASY JOG/ENTER to confirm.
→ The first album title in the recorder memory appears on the display.
- 4 Select the album title you wish to erase by rotating the EASY JOG/ENTER key.



- 5 Press EASY JOG/ENTER to confirm.
→ ERASE MEMORY appears on the display.
- 6 Press the EASY JOG/ENTER key to confirm the erasure of the text for that particular disc.
→ PART E appears on the display.
- 7 Press STORE/MENU to return to the submenu or STOP ■ to exit.

MENU MODE/RECORDING SETTINGS

English

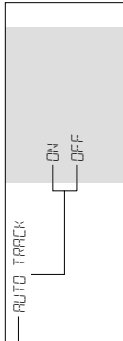
D. Auto track increment/auto track

- 1 Press STORE/MENU.
→ TEXT EDIT appears on the display.
 - 2 Rotate the EASY JOG/ENTER key to select the AUTO TRACK submenu.
→ AUTO TRACK appears on the display.
 - 3 Press EASY JOG/ENTER to confirm.
→ ON or OFF appears on the display.
 - 4 Turn the EASY JOG/ENTER key to select Auto track ON or OFF.
- When ON is selected, track numbers will be automatically incremented during recording.
 - When OFF is selected, you can number the recorded tracks yourself.

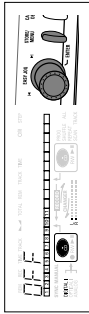

- 5 Press EASY JOG/ENTER to confirm.
→ AUTO TRACK appears on the display.
- 6 Press STORE/MENU to store settings and return to the submenu or STOP ■ to exit.

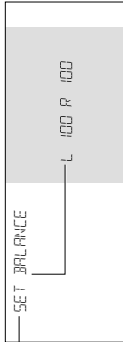
E. Balance (only active in Record/Standby mode)

- 1 Press STORE/MENU.
→ TEXT EDIT appears on the display.
- 2 Rotate the EASY JOG/ENTER key to select the SET BALANCE submenu.
→ SET BALANCE appears on the display.
- 3 Press EASY JOG/ENTER to confirm.
→ L 100 R 100 and L 100 R 100 appear on the display.
- 4 Adjust recording balance by turning the EASY JOG/ENTER key.
 - Turn left: the figure left (L) counts down, right counts up.
 - Turn right: the figure right (R) counts down, left counts up.
- 5 Press EASY JOG/ENTER to confirm.
- 6 Press STORE/MENU to store settings.

Note: The balance setting will not be stored permanently.

FIXING PROBLEMS

English

Will not record

- clean the disc
- check if CDR(W) is an uninitialized disc
- check that the disc is recordable and replace if necessary
- the disc is not an AUDIO disc (KPG045 JISC)
- wrong input source chosen. Input label flashing (CHECK INPUT)
- text memory full (MEMORY FULL / FINALIZE CD). When a CDRW has to be uninitialized for recording. Erase text for other discs(s) or finalize other discs(s) to obtain memory space
- total remaining time not sufficient, try programming tracks (see programming)

Recording is distorted

- make sure the recording level is correct

20 second pause between recordings

- see Autostart recording from external CD player (CD-SYNC)

Player does not react

- switch the ON/OFF button on the front of the player off and back on

JISC RECORDER on display

- a power failure has occurred during recording, the CD recorder is attempting to repair the disc
- if JISC ERROR then appears on the display, the disc cannot be recorded further, and cannot be finalized. But it can still be played on the CD recorder or another CD recorder
- on a CDRW disc, the track being recorded is lost, but further recording and finalization can still be done

TROUBLESHOOTING

If your CD recorder is defective, it is wise to check this list first. You may have forgotten a simple step.

Warning!
Under no circumstances should you attempt to repair the CD recorder yourself as this will invalidate the guarantee.

SYMPTOM

- possible solution:

No power

- ensure that the ON/OFF button is on (read led on): the CD Recorder is in standby mode.

- ensure that the mains cable is plugged in correctly
- switch the recorder OFF and then immediately back ON

Auto track does not work

- check if auto track on is selected in the menu
- check if there are 2.7 seconds silence in between the tracks (analog recording only)
- check if the source is a consumer source with the digital output according to the IEC audio standard
- source is DVD player (no track information)

No sound

- check the audio connections
- if using an amplifier, try using a different source

Amplifier sound is distorted

- check that the CD recorder analog output is not connected to the amplifier Phono input

Play will not start

- ensure that the label of the CD is facing up
- clean the disc
- check that the disc is not defective by trying another disc

Remote control does not work

- point the remote control towards the CD recorder
- check the batteries and replace if necessary
- select the correct source first

4. Mechanical instructions

Wiring diagram

WIRING DIAGRAM CDR779

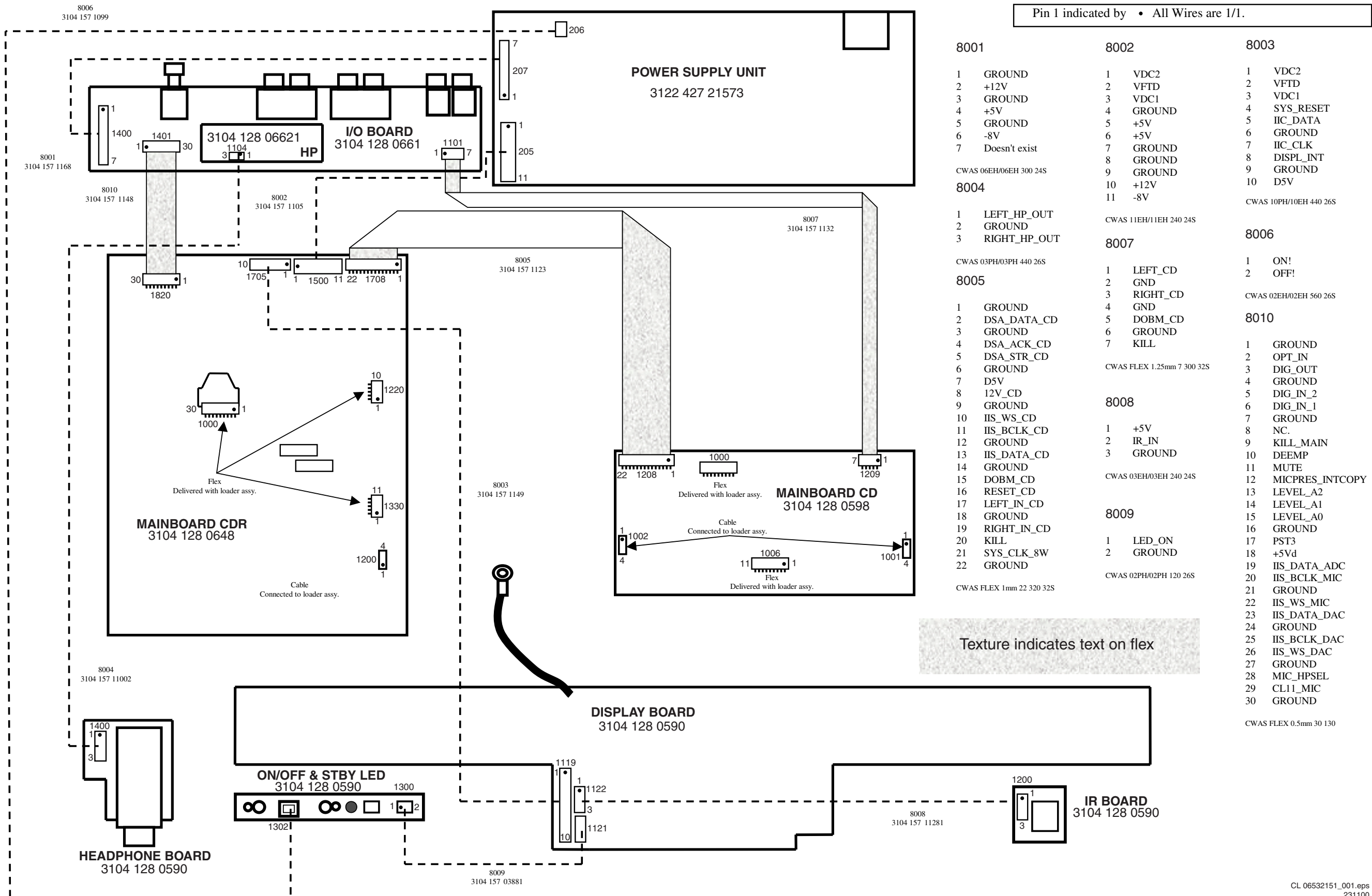

Wiring CD

WIRING DIAGRAM CD LOADER VAL1250

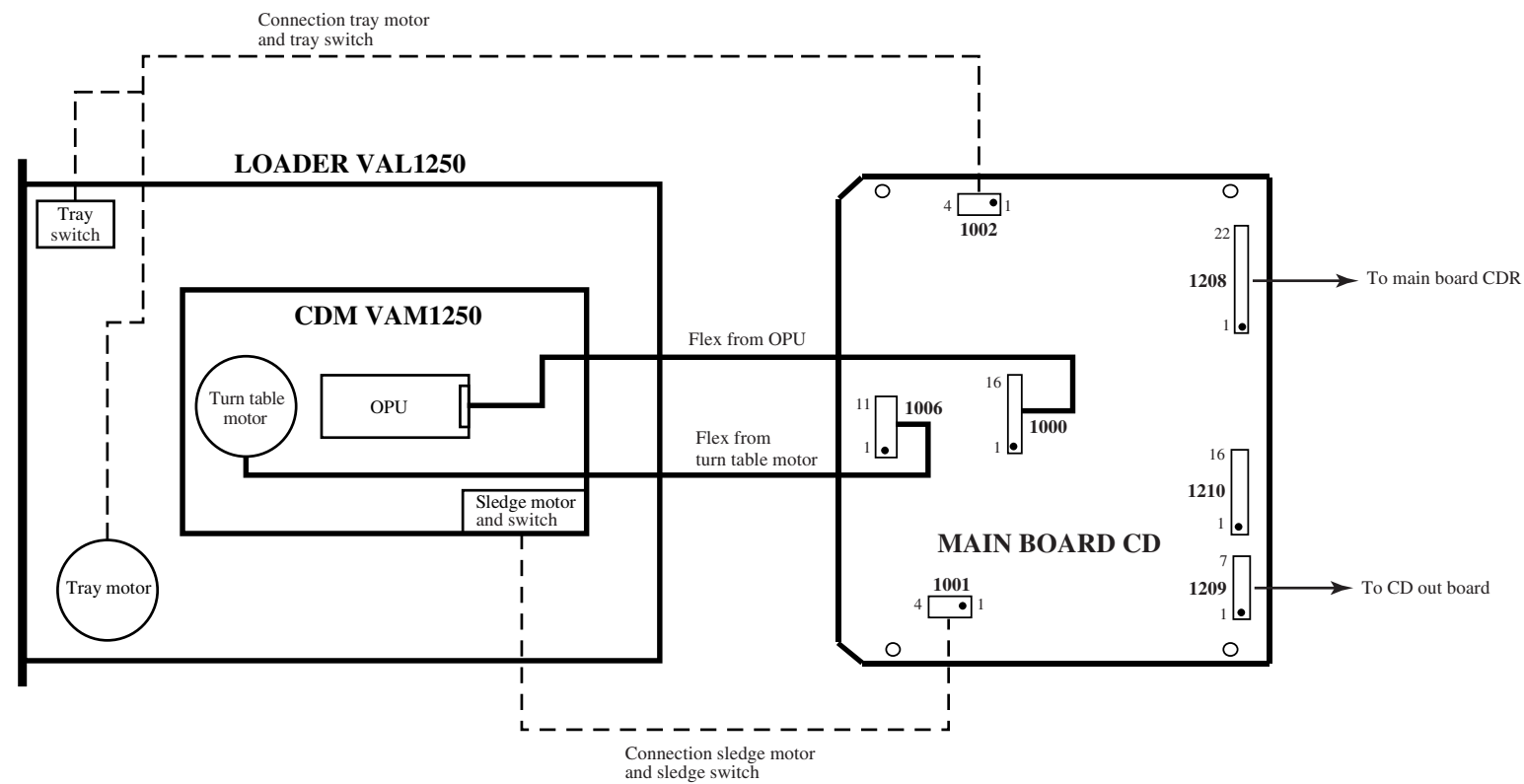

CONNECTOR 1006

- 1 HALL +
- 2 W-
- 3 W+
- 4 V+
- 5 HALL-
- 6 U+
- 7 V-
- 8 U-
- 9 UCOIL
- 10 VCOIL
- 11 WCOIL

CONNECTOR 1000

- 1 VSUB
- 2 HFGND
- 3 VDD
- 4 RF
- 5 LDON
- 6 R2
- 7 R1
- 8 D4/D3
- 9 D2
- 10 D1
- 11 FTC
- 12 RW
- 13 FOC+
- 14 FOC-
- 15 RAD+
- 16 RAD-

CONNECTOR 1002

- 1 HOMESW
- 2 SGND
- 3 TRAY+
- 4 TRAY-

CONNECTOR 1001

- 1 HOMESW
- 2 SGND
- 3 SL-
- 4 SL+

CONNECTOR 1208

- 1 AUDIO R (RIGHT_CD)
- 2 GND
- 3 AUDIO L (LEFT_CD)
- 4 GND
- 5 DOBM5_CD (DOBM_CD)
- 6 GND
- 7 KILL

CONNECTOR 1209

- 1 GND
- 2 CRIN (SYS_CLK_8W)
- 3 KILL
- 4 AUDIO R (RIGHT_IN_CD)
- 5 GND
- 6 AUDIO L (LEFT_IN_CD)
- 7 DSA_RST (SYS_RESET)
- 8 DOBM (DOBM_CD)
- 9 GND
- 10 SCLK (I²S_BCLK_CD)
- 11 GND
- 12 WCLK (I²S_WS_CD)
- 13 DATA (I²S_DATA_CD)
- 14 GND
- 15 +12V
- 16 +5V
- 17 GND
- 18 DSA_ACK (DSA_ACK_CD)
- 19 DSA_STROBE (DSA_STR_CD)
- 20 GND
- 21 DSA_DATA (DSA_DATA_CD)
- 22 GND

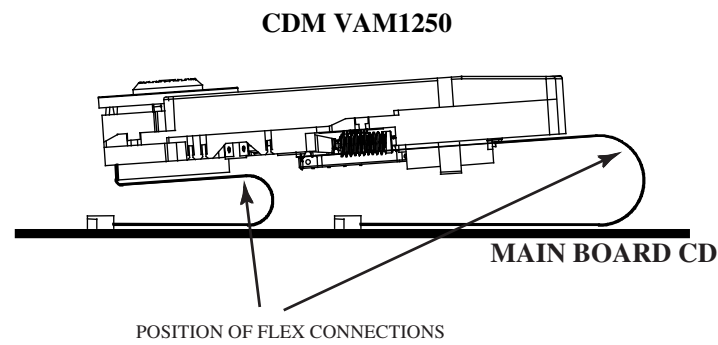
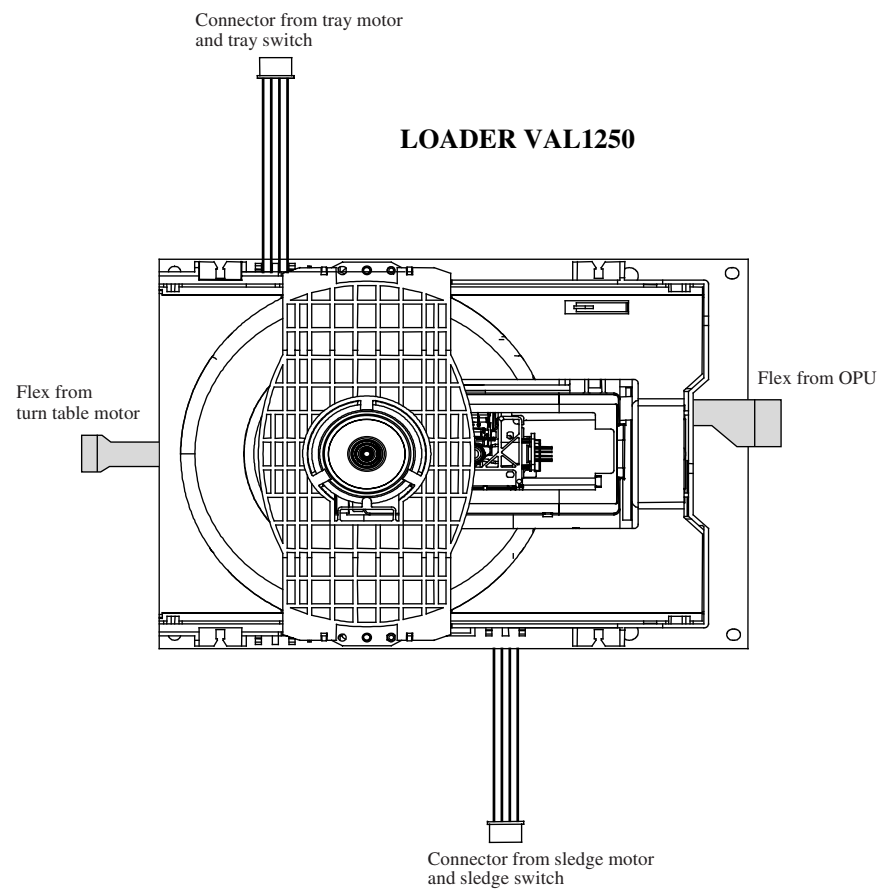

Exploded view CDR779

EXPLODED VIEW CDR779

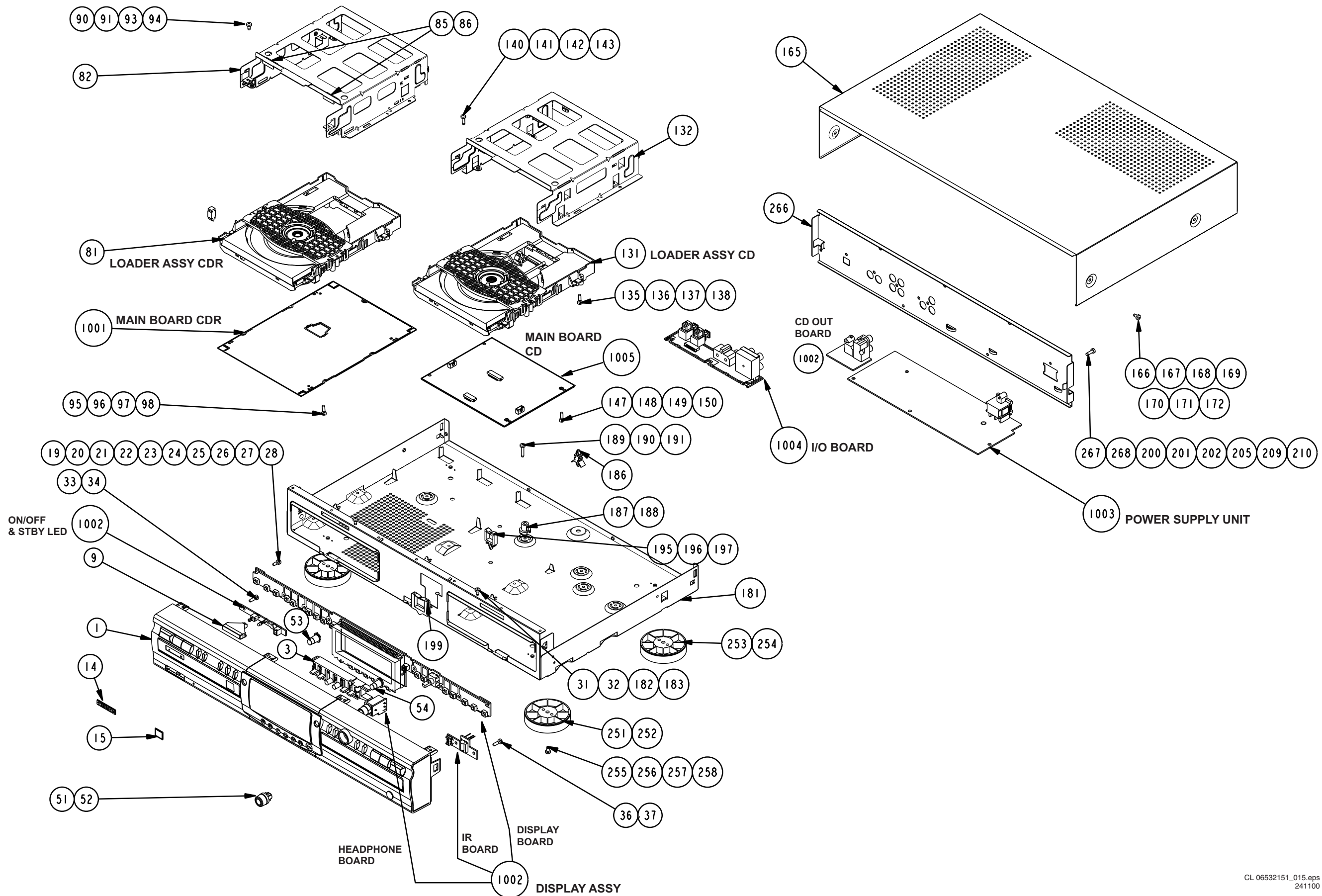

Exploded view CD

EXPLODED VIEW CD LOADER VAL1250

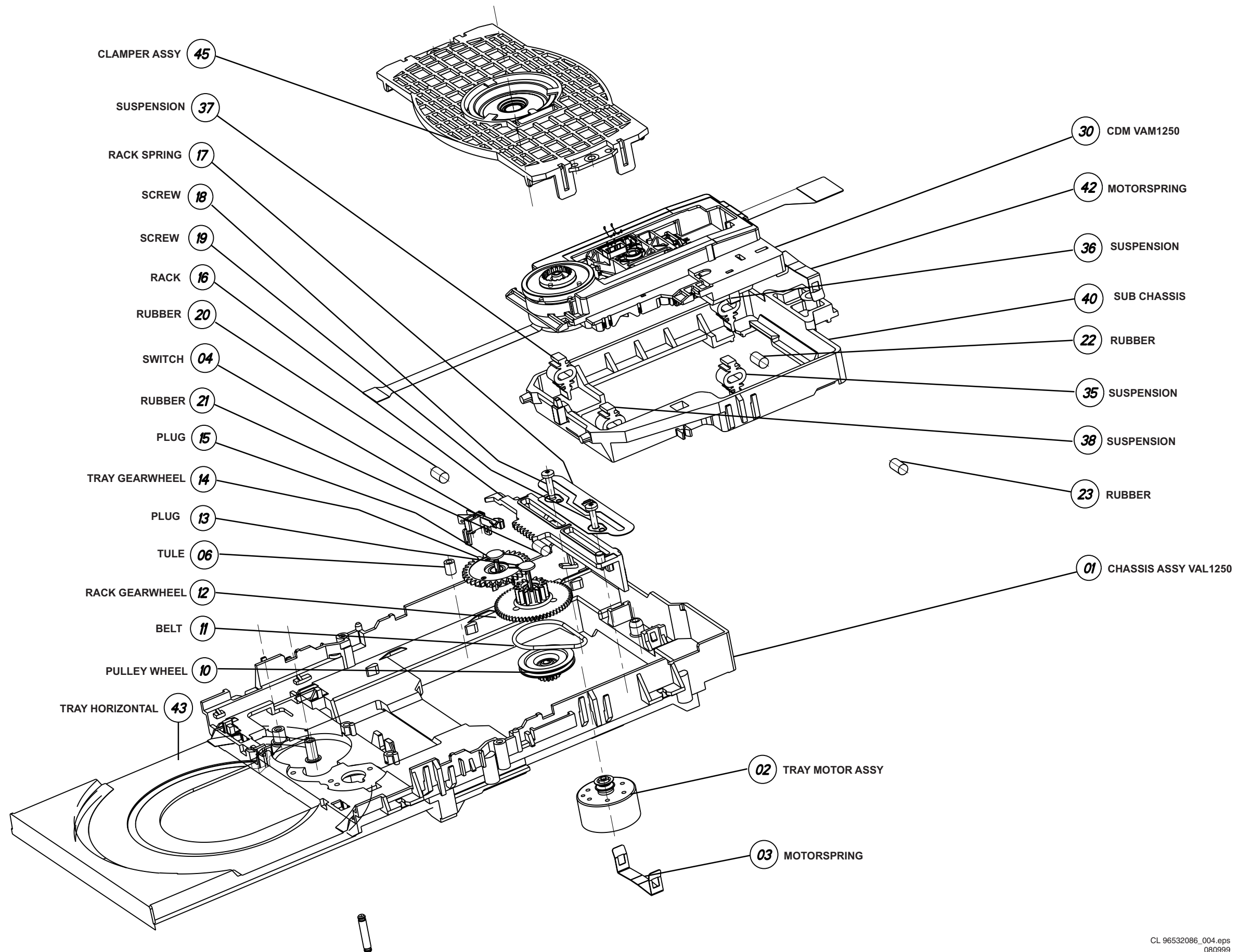

Dismantling 779

DISMANTLING INSTRUCTIONS CDR779

See exploded views for item numbers

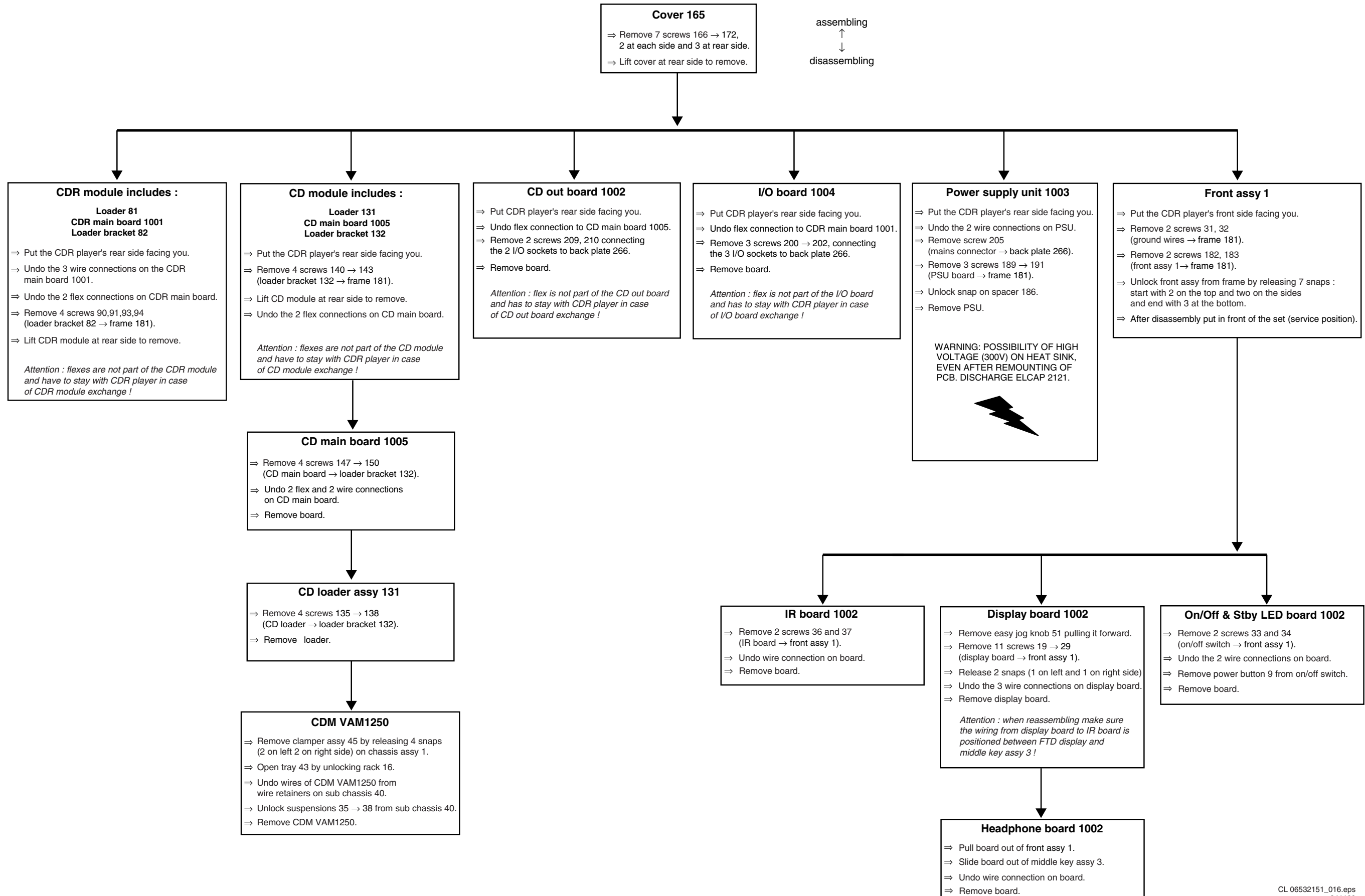

5. Block diagrams, Circuit diagrams and PWB's

Blockdiagram 779

OVERALL BLOCK DIAGRAM CDR779

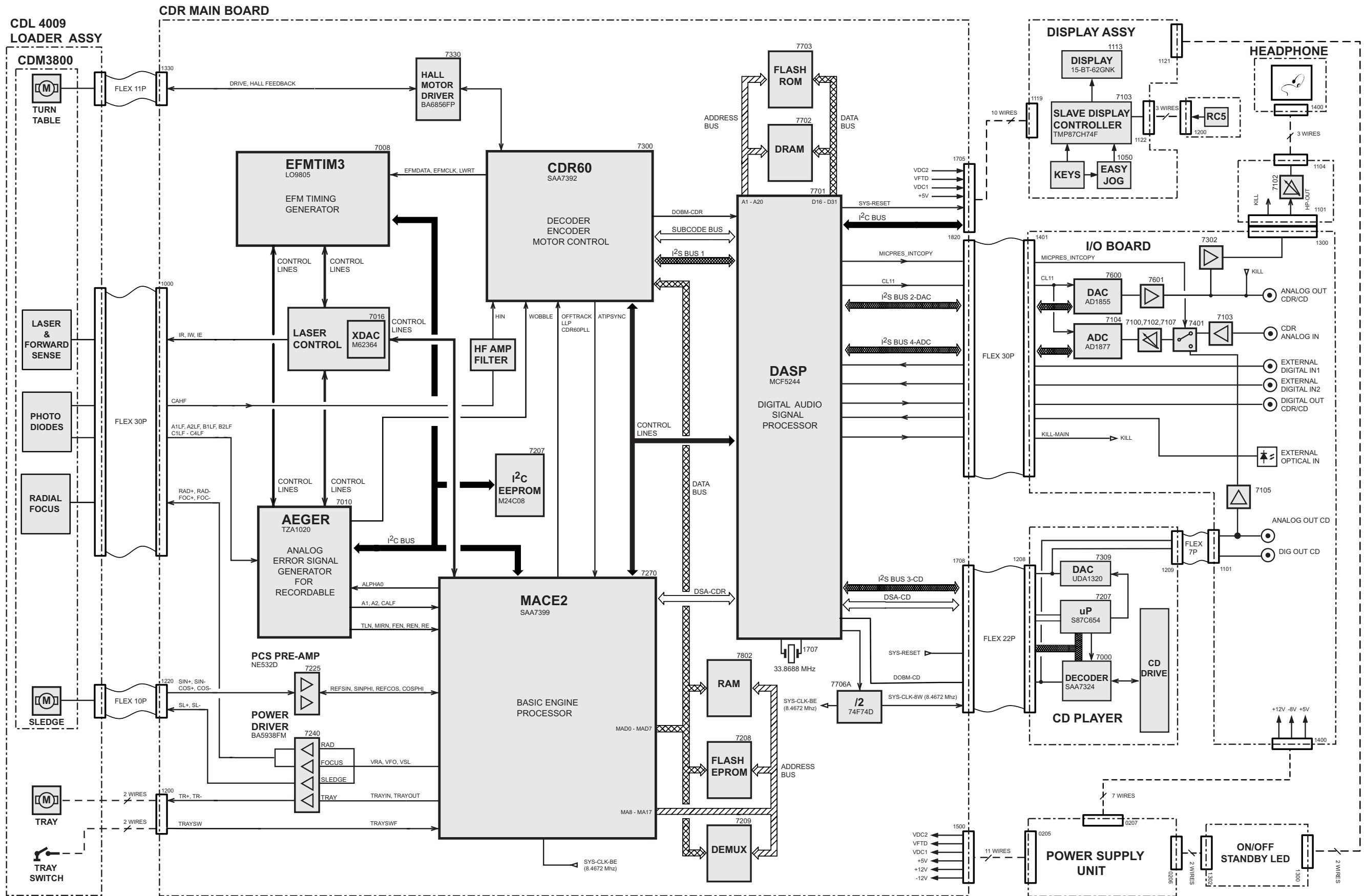

Display 779

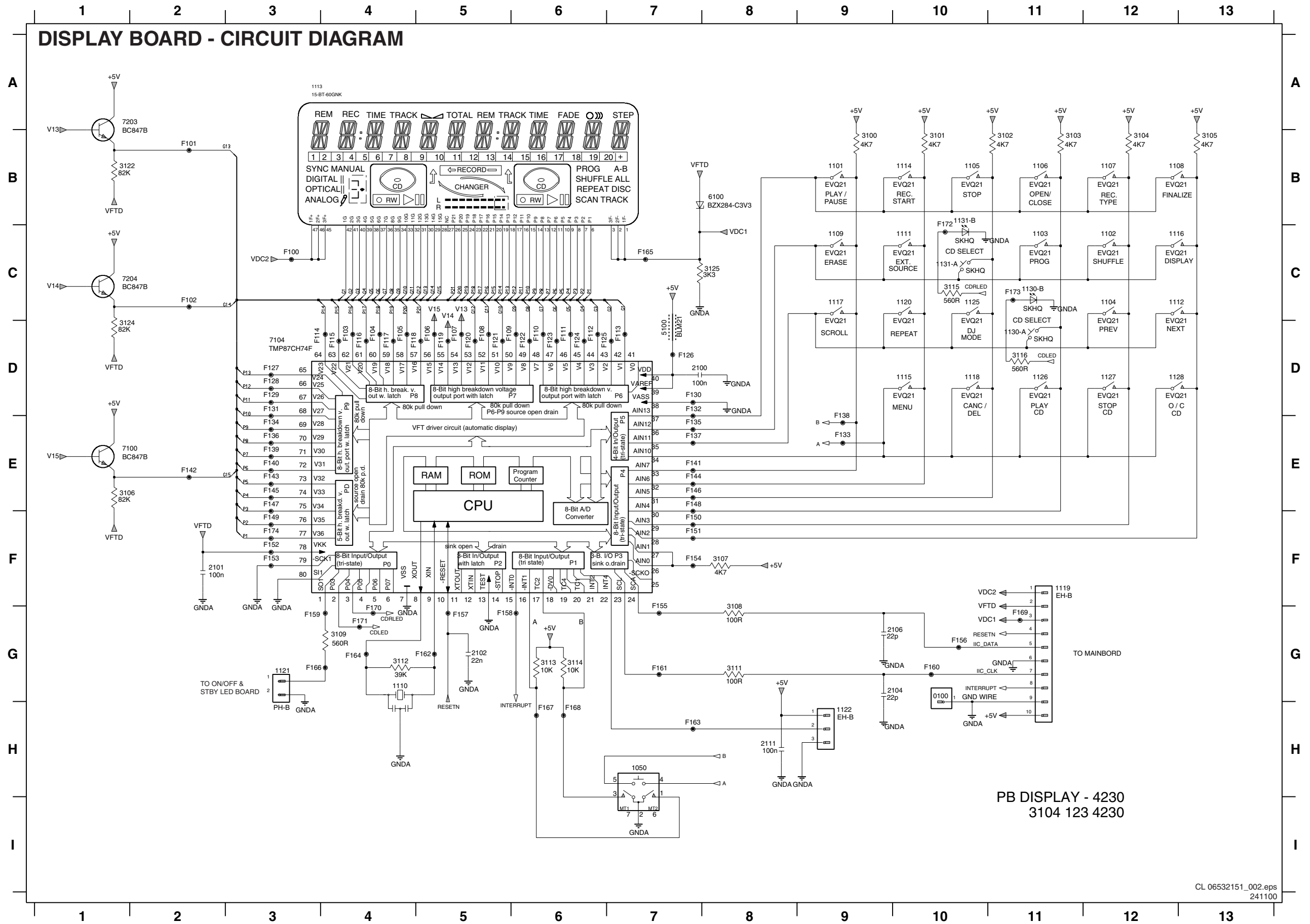

- 0100 G10
- 1050 H7
- 1101 B9
- 1102 C12
- 1103 C11
- 1104 C12
- 1105 B10
- 1106 B11
- 1107 B12
- 1108 B12
- 1109 C9
- 1110 G4
- 1111 C10
- 1112 C12
- 1113 A3
- 1114 B10
- 1115 D10
- 1116 C12
- 1117 C9
- 1118 D10
- 1119 F11
- 1120 C10
- 1121 G3
- 1122 H9
- 1125 C10
- 1126 D11
- 1127 D12
- 1128 D12
- 1130-A D11
- 1130-B C11
- 1131-A B10
- 1131-B B10
- 2100 D7
- 2101 F2
- 2102 G5
- 2104 G10
- 2106 G10
- 2111 H8
- 3100 B9
- 3101 B10
- 3102 B11
- 3103 B11
- 3104 B12
- 3105 B13
- 3106 E1
- 3107 F8
- 3108 G8
- 3109 G4
- 3111 G8
- 3112 G4
- 3113 G6
- 3114 G6
- 3115 C10
- 3116 D11
- 3122 B1
- 3124 C1
- 3125 C8
- 5100 D7
- 6100 B8
- 7100 E1
- 7104 D3
- 7203 A1
- 7204 C1
- F100 C3
- F101 B2
- F102 C2
- F103 D4
- F104 D4
- F105 D4
- F106 D5
- F107 D5
- F108 D5
- F109 D5
- F110 D6
- F111 D6
- F112 D6
- F113 D7
- F114 D3
- F115 D4
- F116 D4
- F117 D4
- F118 D4
- F119 D5
- F120 D5
- F121 D5
- F122 D6
- F123 D6
- F124 D6
- F125 D6
- F126 D7
- F127 D3
- F128 D3
- F129 D3
- F130 D7
- F131 D3
- F132 D7
- F133 E3
- F135 E7
- F136 E3
- F137 E7
- F138 E9
- F139 E3
- F140 E3
- F141 E7
- F142 E2
- F143 E3
- F144 E7
- F145 E3
- F146 E7

PB DISPLAY - 4230
3104 123 4230

Display 779

DISPLAY BOARD - BOTTOM VIEW

2100 B6 2106 B7 2501 B10 3100 A8 3104 A10 3108 B7 3113 A5 3122 A6 3501 B11 3999 B8 4003 A10 4007 A9 4011 A9 4015 A8 4019 A8 4023 A8 4027 A7 4031 A7 4035 A7 4040 B7 4044 B6 4051 A6 4055 A4 4059 B7 4068 B5 4077 B6 4083 A4 4087 A2 4091 A1 4100 B7 4108 B5 4114 B6 7104 A6 7501 B10
 2101 B5 2111 B7 2502 B10 3101 A9 3105 A9 3109 A5 3114 A5 3124 A6 3502 B11 4000 A11 4004 A9 4008 A9 4012 A8 4016 A8 4020 A8 4024 A8 4028 A7 4032 A7 4036 A7 4041 B7 4045 B6 4052 A5 4056 A4 4061 B4 4066 B5 4072 B4 4076 B5 4080 A4 4084 A3 4088 A2 4092 B8 4105 B6 4109 B5 4115 B6 7100 A6 7203 A6 7999 B8
 2102 B9 2400 B9 2503 B11 3102 A10 3106 A6 3111 B7 3116 B4 3500 B10 4001 A11 4005 A9 4009 A9 4013 A8 4017 A8 4021 A8 4025 A7 4029 A7 4033 A7 4037 B7 4042 B7 4046 B6 4053 A4 4057 A4 4062 B5 4068 B5 4074 B4 4078 B5 4082 A3 4086 A3 4090 A7 4094 B8 4106 B6 4110 B6 4114 B6 7106 A6 7204 A6 7500 B11

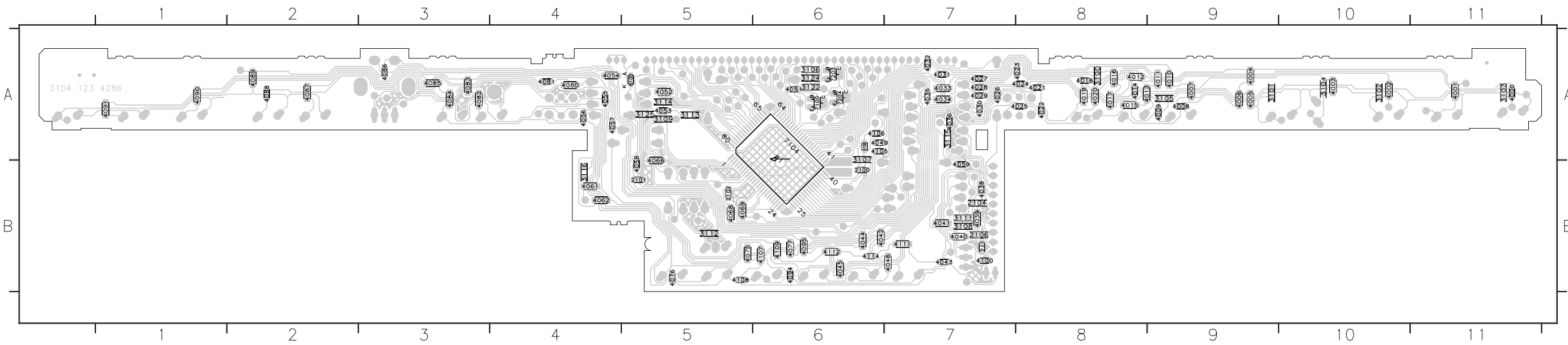

DISPLAY BOARD - TOP VIEW

0100 A8 1101 A1 1104 A8 1107 A2 1110 B7 1113 A6 1116 B6 1119 B5 1122 B5 1127 A11 1131 A4 1301 B9 1401 A3 1502 A1 6200 B9 9002 A5 9005 A5 9008 A5 9011 B5 9014 A5 9017 A6 9020 A7 9023 A8 9027 A7
 0400 B3 1102 B9 1105 A2 1108 A3 1111 A4 1114 A2 1117 B6 1120 B7 1125 B7 1128 A11 1200 B10 1302 B3 1500 B7 5500 B2 9001 A5 9004 A5 9007 A5 9010 B5 9013 B5 9016 B7 9018 A6 9021 A8 9024 A8 9028 B7
 1050 A9 1103 B9 1106 A1 1109 A4 1112 A9 1115 A10 1118 A10 1121 B5 1126 A11 1130 A8 1300 B11 1400 B3 1501 B7

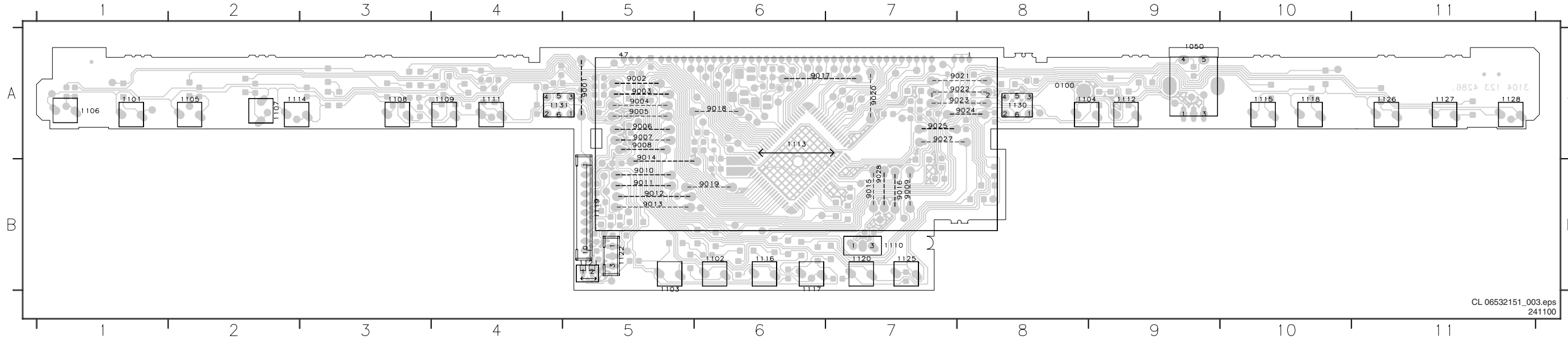

IR on/off

IR BOARD CDR779 - CIRCUIT DIAGRAM

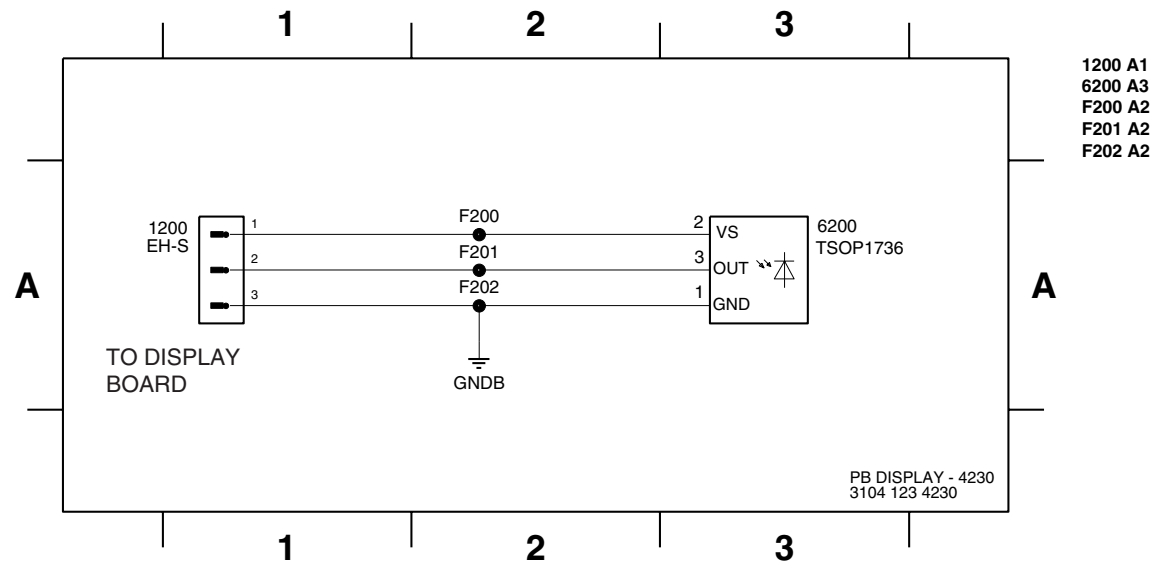

IR BOARD - FRONT VIEW

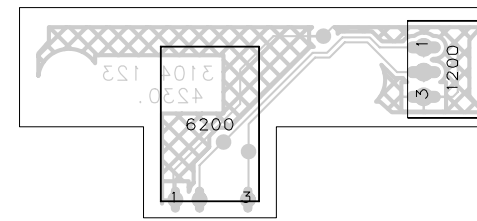

IR BOARD - BACK VIEW

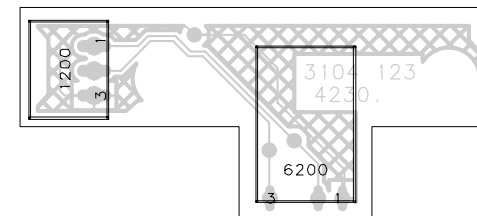

ON/OFF & STBY LED BOARD CDR779 - CIRCUIT DIAGRAM

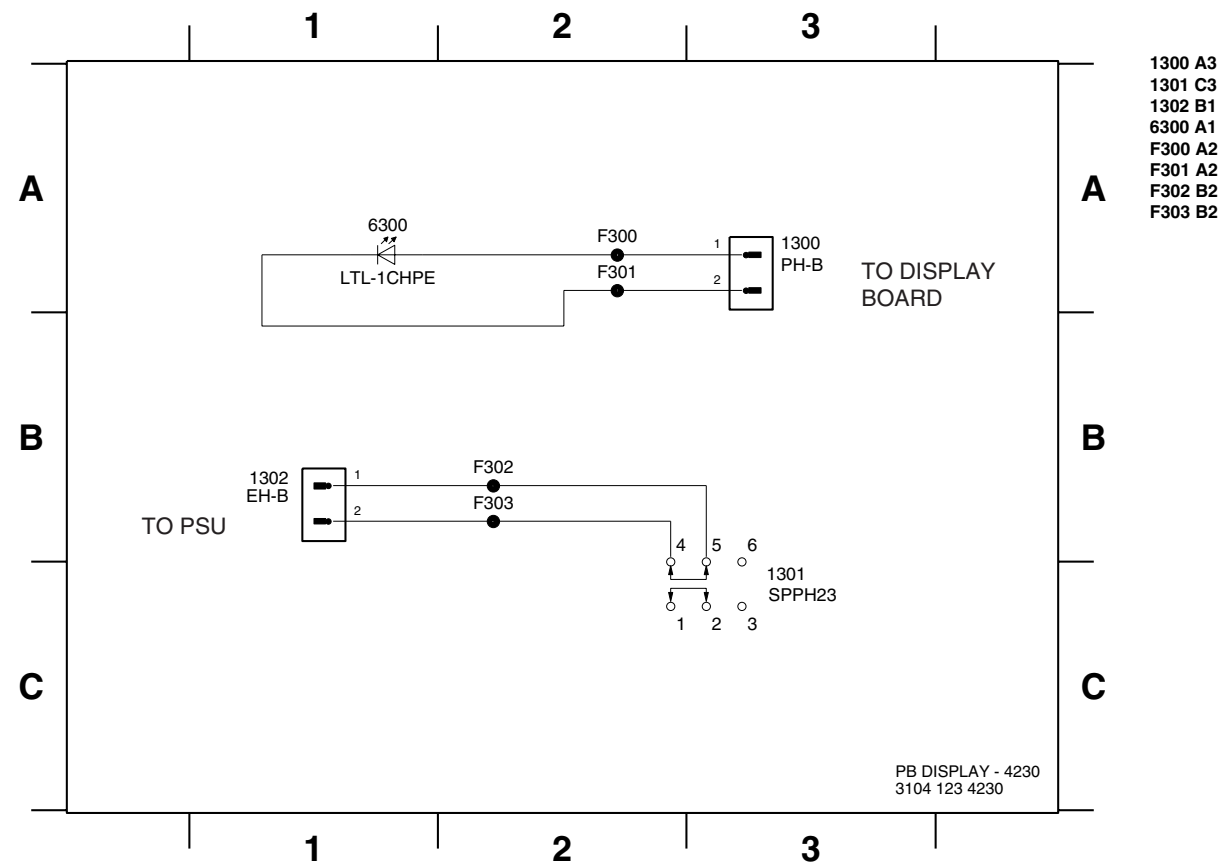

ON/OFF & STBY LED BOARD - FRONT VIEW

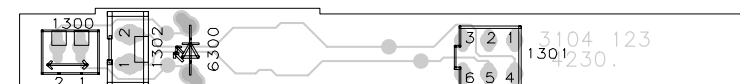

ON/OFF & STBY LED BOARD - BACK VIEW

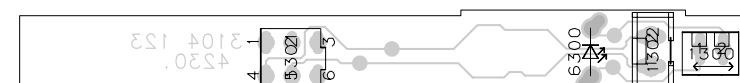

HPCD out

HEADPHONE BOARD - CIRCUIT DIAGRAM

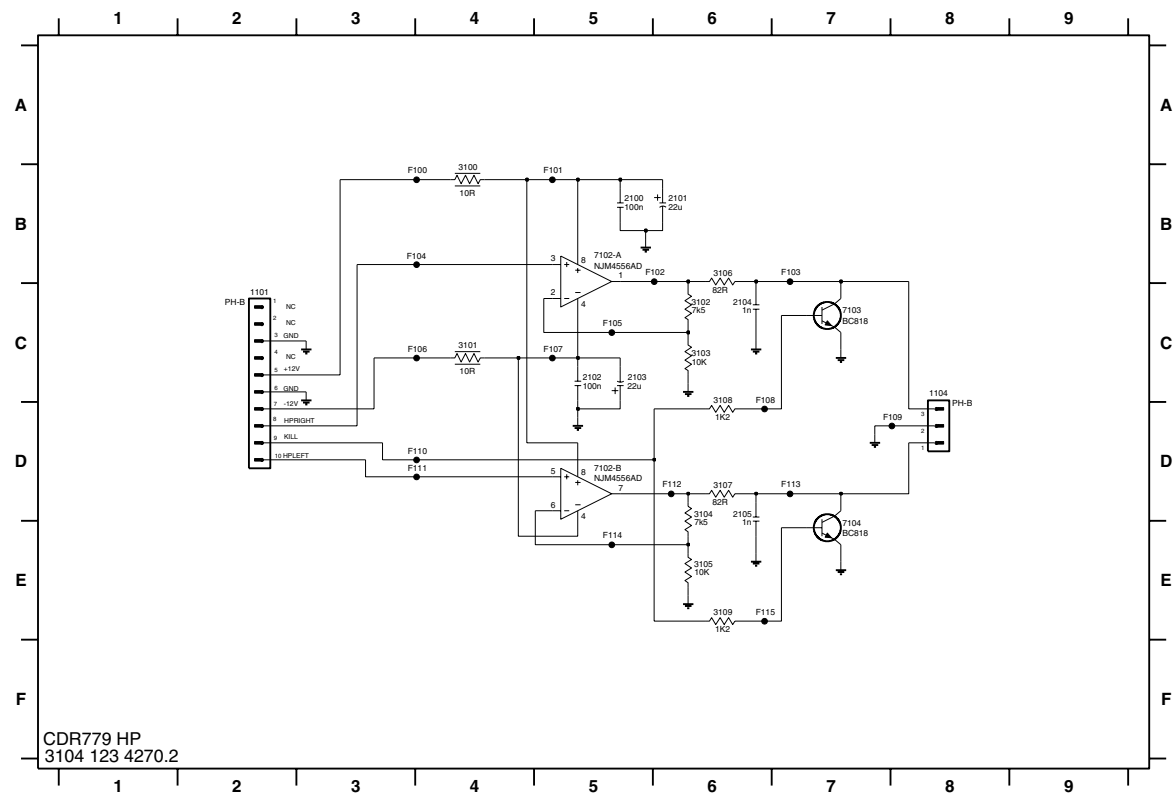

- 1101 C2
- 1104 C4
- 2100 B5
- 2101 B6
- 2102 C5
- 2103 C5
- 2104 C6
- 2105 D6
- 3100 B4
- 3101 C4
- 3102 C6
- 3103 C6
- 3104 D6
- 3105 E6
- 3106 B6
- 3107 D6
- 3108 D6
- 3109 E6
- 7102-A B5
- 7102-B D5
- 7103 C7
- 7104 E7
- F100 B4
- F101 B5
- F102 B6
- F103 B7
- F104 B4
- F105 C5
- F106 C4
- F107 C5
- F108 D6
- F109 D6
- F110 D4
- F111 D4
- F112 D6
- F113 D7
- F114 E5
- F115 E6

HEADPHONE BOARD - TOP VIEW

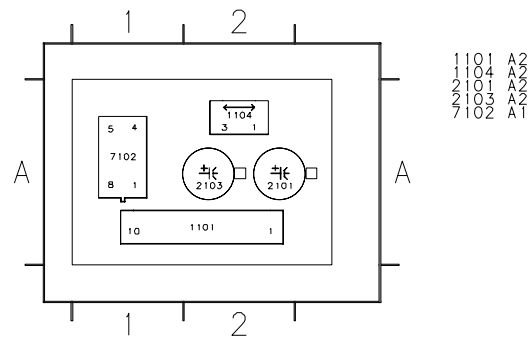

- 1101 A2
- 1104 A2
- 2103 A2
- 7102 A1

HEADPHONE BOARD - BOTTOM VIEW

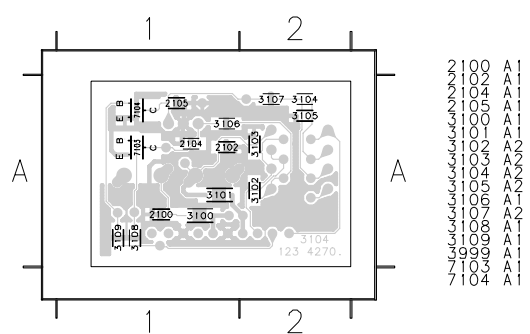

- 2100 A1
- 2101 A1
- 2102 A1
- 2103 A1
- 2104 A2
- 2105 A2
- 3100 A2
- 3101 A2
- 3102 A2
- 3103 A2
- 3104 A2
- 3105 A2
- 3106 A2
- 3107 A2
- 3108 A2
- 3109 A2
- 123 4270.2
- 7103 A1
- 7104 A1

CD OUT BOARD - CIRCUIT DIAGRAM

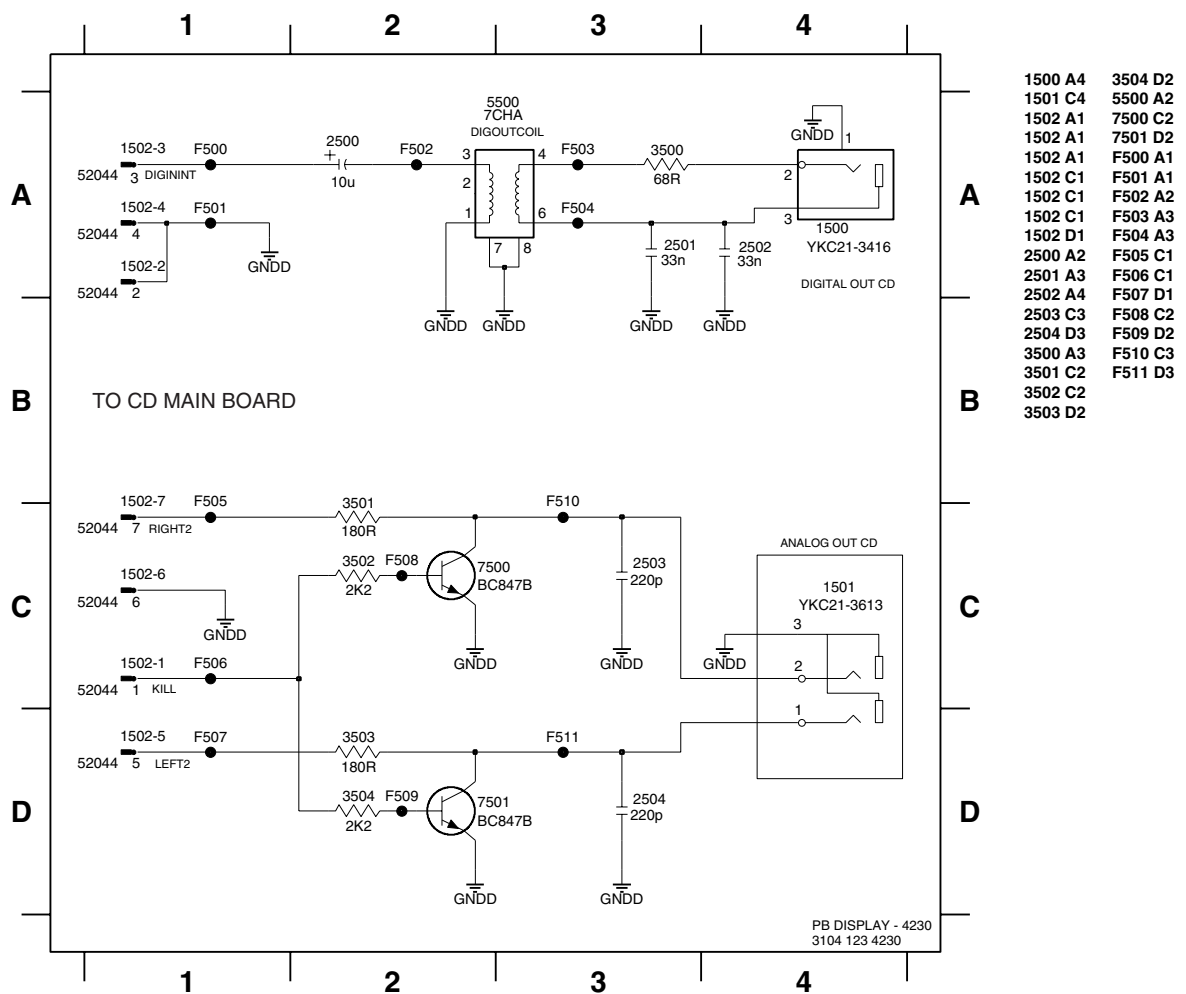

- 1500 A4
- 1501 C4
- 1502 A1
- 1502 A1
- 1502 A1
- 1502 C1
- 1502 C1
- 1502 C1
- 1502 D1
- 2500 A2
- 2501 A3
- 2502 A4
- 2503 C3
- 2504 D3
- 3500 A3
- 3501 C2
- 3502 C2
- 3503 D2
- 3504 D2
- 5500 A2
- 7500 C2
- 7501 D2
- F500 A1
- F501 A1
- F502 A2
- F503 A3
- F504 A3
- F505 C1
- F506 C1
- F507 D1
- F508 C2
- F509 D2
- F510 C3
- F511 D3

CD OUT BOARD - TOP VIEW

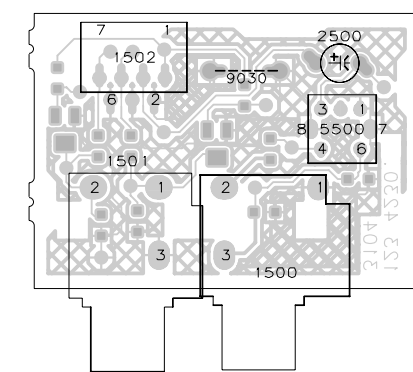

CD OUT BOARD - BOTTOM VIEW

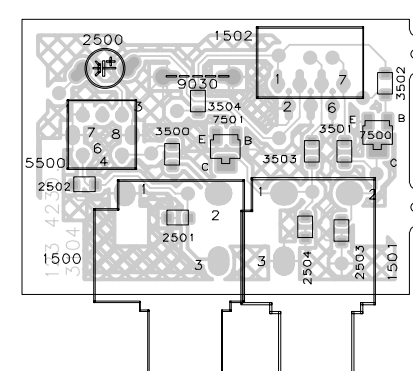

I/O board: Ext DAC

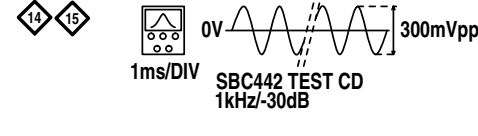
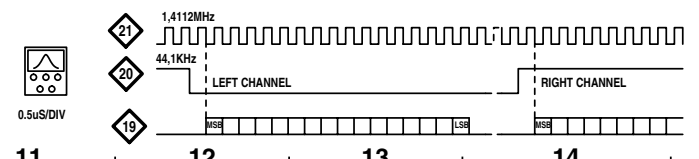
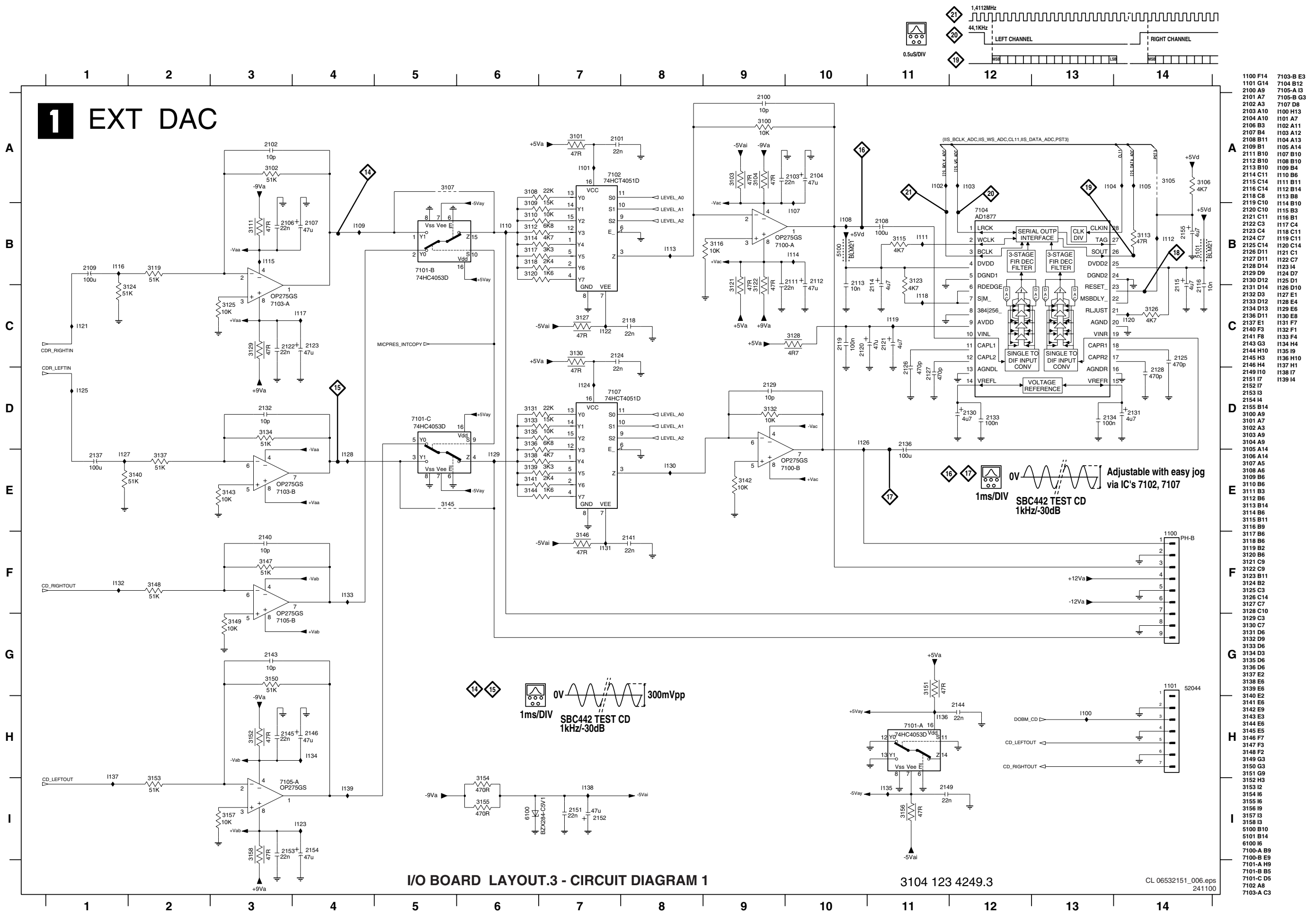

- 1100 F14
- 1101 G14
- 2100 A9
- 2101 A7
- 2102 A3
- 2103 A10
- 2104 A10
- 2106 B3
- 2107 B4
- 2108 B11
- 2109 B1
- 2110 B10
- 2111 B10
- 2112 B10
- 2113 B10
- 2114 C11
- 2115 C14
- 2116 C14
- 2118 C8
- 2119 C10
- 2120 C10
- 2121 C11
- 2122 C3
- 2123 C4
- 2124 C7
- 2125 C14
- 2126 D11
- 2127 D11
- 2128 D14
- 2129 D9
- 2130 D12
- 2131 D14
- 2132 D3
- 2133 D12
- 2134 D13
- 2136 D11
- 2137 E1
- 2140 F3
- 2141 F8
- 2143 G3
- 2144 H10
- 2145 H3
- 2146 H4
- 2149 I10
- 2151 I7
- 2152 I7
- 2153 I3
- 2154 I4
- 2155 B14
- 3100 A9
- 3101 A7
- 3102 A3
- 3103 A9
- 3104 A9
- 3105 A14
- 3106 A14
- 3107 A5
- 3108 A6
- 3109 B6
- 3110 B6
- 3111 B3
- 3112 B6
- 3113 B14
- 3114 B6
- 3115 B11
- 3116 B9
- 3117 B6
- 3118 B6
- 3119 B2
- 3120 B6
- 3121 C9
- 3122 C9
- 3123 B11
- 3124 B2
- 3125 C3
- 3126 C14
- 3127 C7
- 3128 C10
- 3129 C3
- 3130 C7
- 3131 D6
- 3132 D9
- 3133 D6
- 3134 D3
- 3135 D6
- 3136 D6
- 3137 E2
- 3138 E6
- 3139 E6
- 3140 E2
- 3141 E6
- 3142 E9
- 3143 E3
- 3144 E6
- 3145 E5
- 3146 F7
- 3147 F3
- 3148 F2
- 3149 G3
- 3150 G3
- 3151 G9
- 3152 H3
- 3153 I2
- 3154 I6
- 3155 I6
- 3156 I9
- 3157 I3
- 3158 I3
- 5100 B10
- 5101 B14
- 6100 I6
- 7100-A B9
- 7100-B E9
- 7101-A H9
- 7101-B B5
- 7101-C D5
- 7102 A8
- 7103-A C3
- 7103-B E3
- 7104 B12
- 7105-A I3
- 7105-B G3
- 7107 D8
- 7108 H13
- 7109 A7
- 7110 A12
- 7111 B11
- 7112 B14
- 7113 B8
- 7114 B10
- 7115 B3
- 7116 B1
- 7117 C4
- 7118 C11
- 7119 C11
- 7120 C14
- 7121 C1
- 7122 C7
- 7123 I4
- 7124 I4
- 7125 D7
- 7126 D11
- 7127 D11
- 7128 E8
- 7129 E6
- 7130 E8
- 7131 F7
- 7132 F1
- 7133 F4
- 7134 H4
- 7135 I9
- 7136 H10
- 7137 H1
- 7138 I7
- 7139 I4

I/O BOARD LAYOUT.3 - CIRCUIT DIAGRAM 1

3104 123 4249.3

CL 06532151_006.eps
241100

I/O board: Cinch

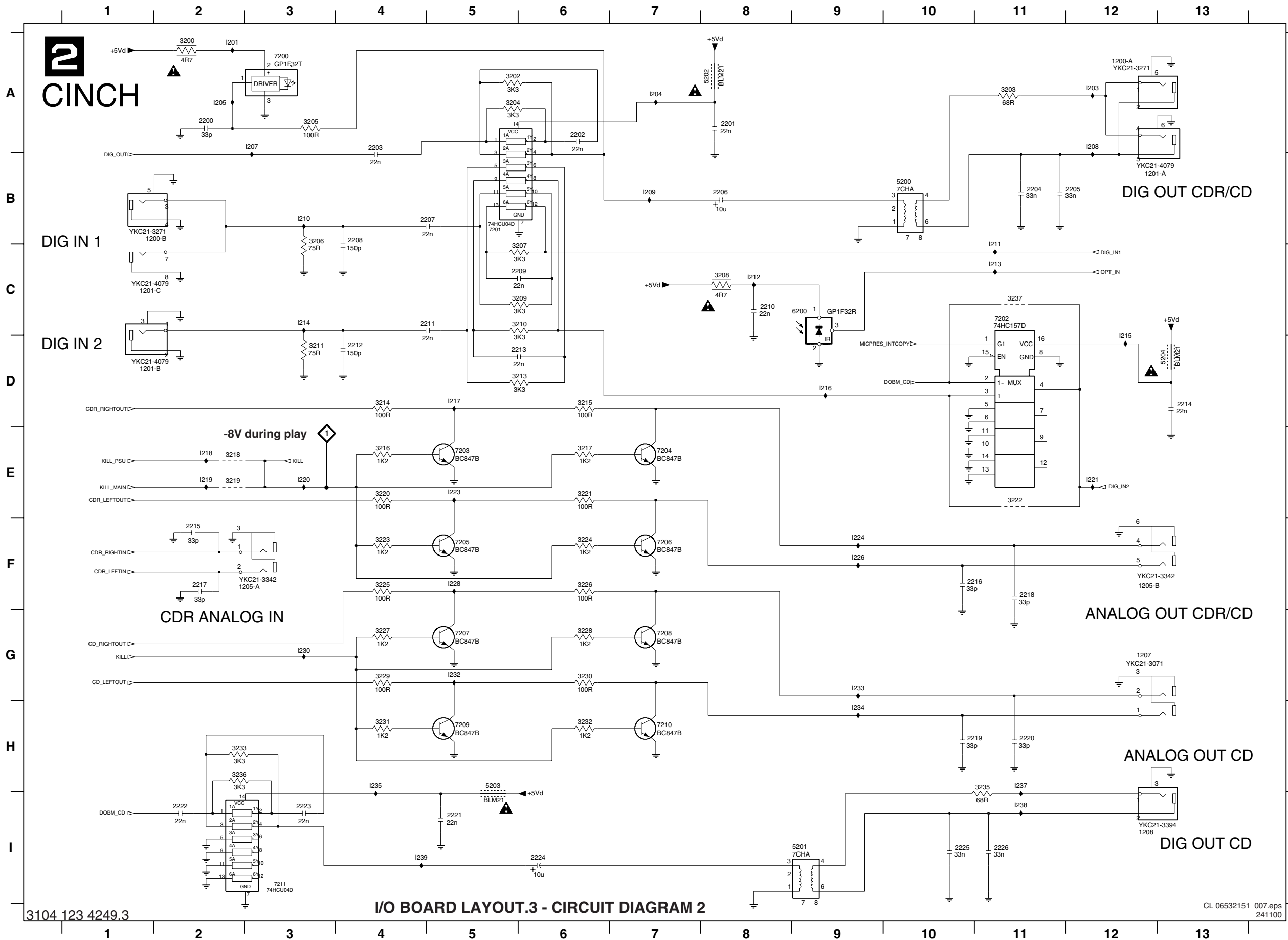

- 1200-A A12
- 1200-B B2
- 1201-A B12
- 1201-B D1
- 1201-C C1
- 1205-A F3
- 1205-B F12
- 1207 C12
- 1208 H2
- 2200 A2
- 2201 A8
- 2202 A6
- 2203 A4
- 2204 B11
- 2205 B12
- 2206 B8
- 2207 B5
- 2208 B4
- 2209 C6
- 2210 C8
- 2211 C5
- 2212 D4
- 2213 D6
- 2214 D13
- 2215 F2
- 2216 F11
- 2217 F2
- 2218 F11
- 2219 H11
- 2220 H11
- 2221 I5
- 2222 I2
- 2223 I3
- 2224 I6
- 2225 I10
- 2226 I11
- 3200 A2
- 3202 A5
- 3203 A11
- 3204 A5
- 3205 A3
- 3206 B3
- 3207 C6
- 3208 C8
- 3209 C6
- 3210 C6
- 3211 D3
- 3213 D6
- 3214 D4
- 3215 D6
- 3216 E4
- 3217 E6
- 3218 E2
- 3219 E2
- 3220 E4
- 3221 E6
- 3222 E11
- 3223 F4
- 3224 F6
- 3225 F4
- 3226 F6
- 3227 G4
- 3228 G6
- 3229 G4
- 3230 G6
- 3231 H4
- 3232 H6
- 3233 H2
- 3235 H11
- 3236 H2
- 3237 C11
- 5200 B10
- 5201 I9
- 5202 A8
- 5203 H5
- 5204 D13
- 6200 C9
- 7200 A3
- 7201 B5
- 7202 C11
- 7203 E5
- 7204 E7
- 7205 F5
- 7206 F7
- 7207 G5
- 7208 G7
- 7209 H5
- 7210 H7
- 7211 I3
- I201 A2
- I203 A12
- I204 A7
- I205 A2
- I207 A3
- I208 A12
- I209 B7
- I210 B3
- I211 C11
- I212 C8
- I213 C11
- I214 C3
- I215 D12
- I216 D9
- I217 D5
- I218 E2
- I219 E2
- I220 E3
- I221 E12
- I223 E5
- I224 F9
- I226 F9
- I228 F5
- I230 G3
- I232 G5
- I233 G9
- I234 H9
- I235 H4

I/O board: Mic ADC

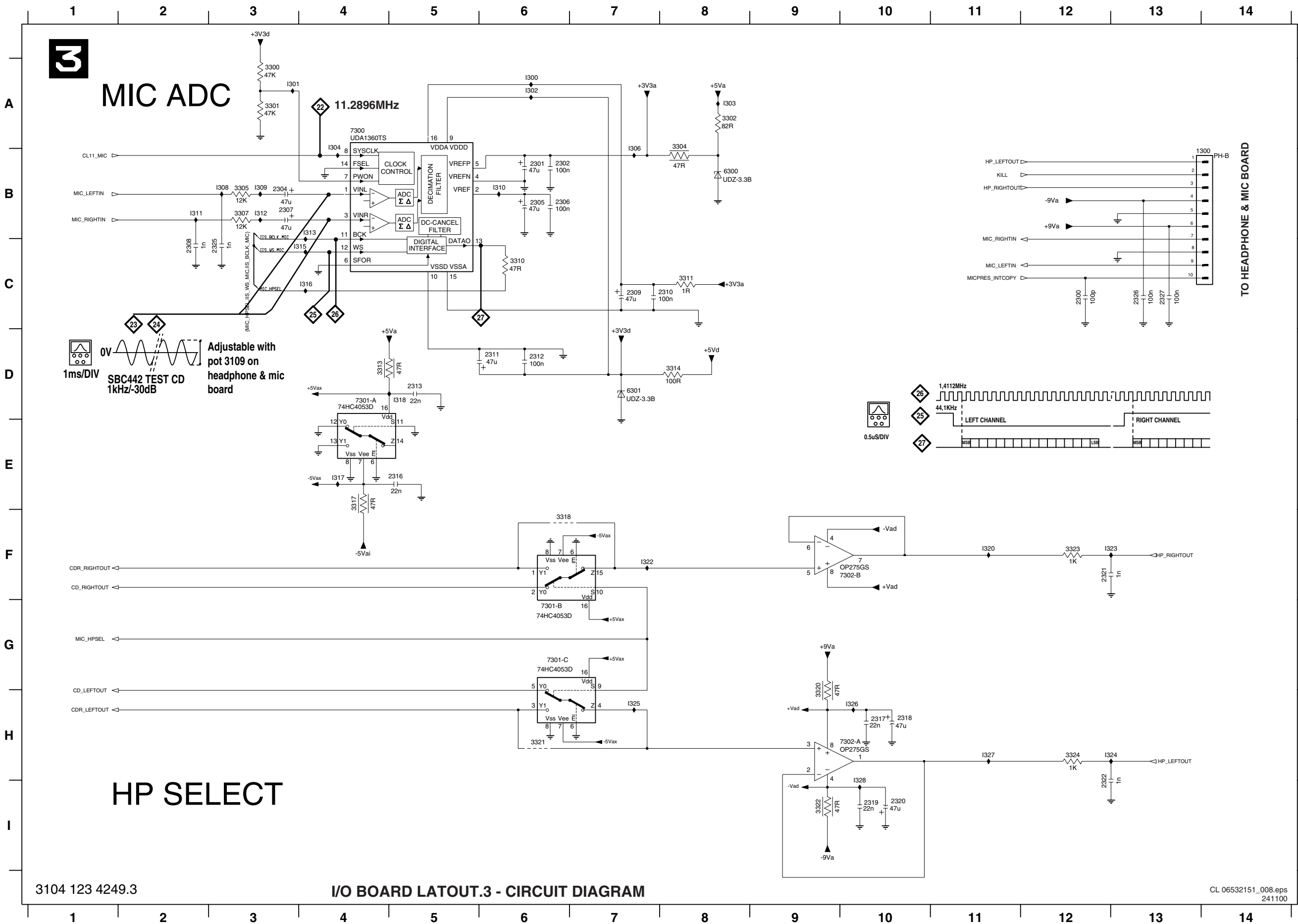

- 1300 B13
- 2300 C12
- 2301 B6
- 2302 B6
- 2304 B3
- 2305 B6
- 2306 B6
- 2307 B3
- 2308 C2
- 2309 C7
- 2310 C8
- 2311 D6
- 2312 D6
- 2313 D5
- 2316 E5
- 2317 H10
- 2318 H10
- 2319 H10
- 2321 F12
- 2322 H12
- 2325 C3
- 2326 C13
- 2327 C13
- 3300 A3
- 3301 A3
- 3302 A8
- 3304 A8
- 3305 B3
- 3307 B3
- 3310 C6
- 3311 C8
- 3313 D4
- 3314 D8
- 3317 E4
- 3318 F6
- 3320 H9
- 3321 H6
- 3322 I9
- 3323 F12
- 3324 H12
- 6300 B8
- 6301 D7
- 7300 A4
- 7301-A D4
- 7301-B G6
- 7301-C G6
- 7302-A H9
- 7302-B F9
- I300 A6
- I301 A3
- I302 A6
- I303 A8
- I304 A4
- I306 A7
- I308 B3
- I309 B3
- I310 B6
- I311 B2
- I312 B3
- I313 B4
- I315 C4
- I316 C4
- I317 E4
- I318 D5
- I320 F11
- I322 F7
- I323 F13
- I324 H13
- I325 H7
- I326 H10
- I327 H11
- I328 H10

I/O board: Power supply

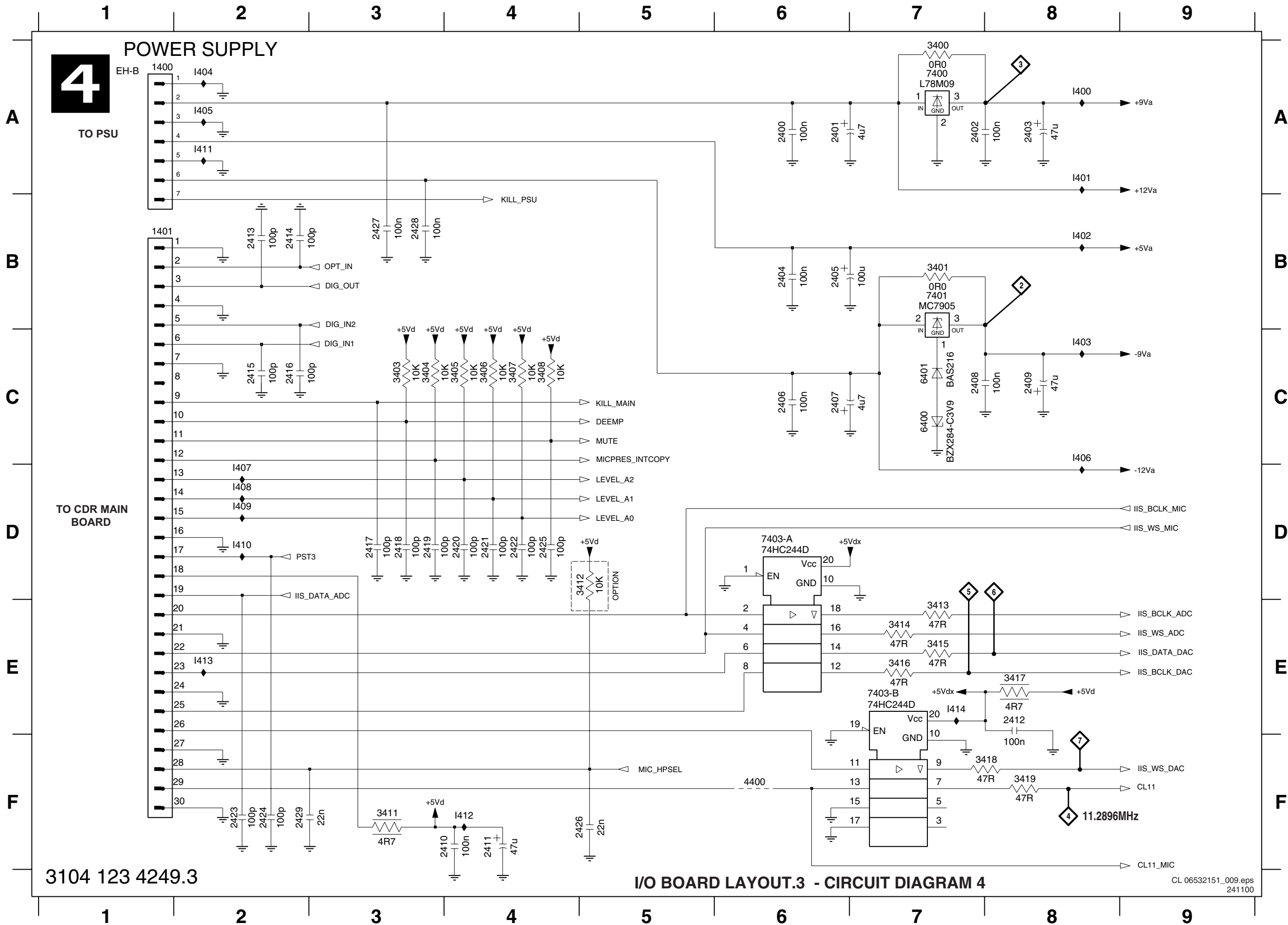

- 1400 A1
- 1401 B1
- 2400 A6
- 2401 A6
- 2402 A7
- 2403 A8
- 2404 B6
- 2405 B6
- 2406 C6
- 2407 C6
- 2408 C7
- 2409 C8
- 2410 F4
- 2411 F4
- 2412 E8
- 2413 B2
- 2414 B2
- 2415 C2
- 2416 C2
- 2417 D3
- 2418 D3
- 2419 D3
- 2420 D4
- 2421 D4
- 2422 D4
- 2423 F2
- 2424 F2
- 2425 D4
- 2426 F5
- 2427 B3
- 2428 B3
- 2429 F7
- 3400 A7
- 3401 B7
- 3403 C3
- 3404 C3
- 3405 C4
- 3406 C4
- 3407 C4
- 3408 C4
- 3411 F3
- 3412 D5
- 3413 E7
- 3414 E7
- 3415 E7
- 3416 E7
- 3417 E8
- 3418 F8
- 3419 F8
- 4400 F6
- 6400 C7
- 7400 A7
- 7401 B7
- 7403-A D6
- 7403-B E7
- I400 A8
- I401 A8
- I402 B8
- I403 C8
- I404 A2
- I405 A2
- I406 C8
- I407 D2
- I408 D2
- I409 D2
- I410 D2
- I411 A2
- I412 F4
- I413 E2
- I414 E7

3104 123 4249.3

I/O BOARD LAYOUT.3 - CIRCUIT DIAGRAM 4

CL 06532151_009.eps
241100

I/O board: DAC filter

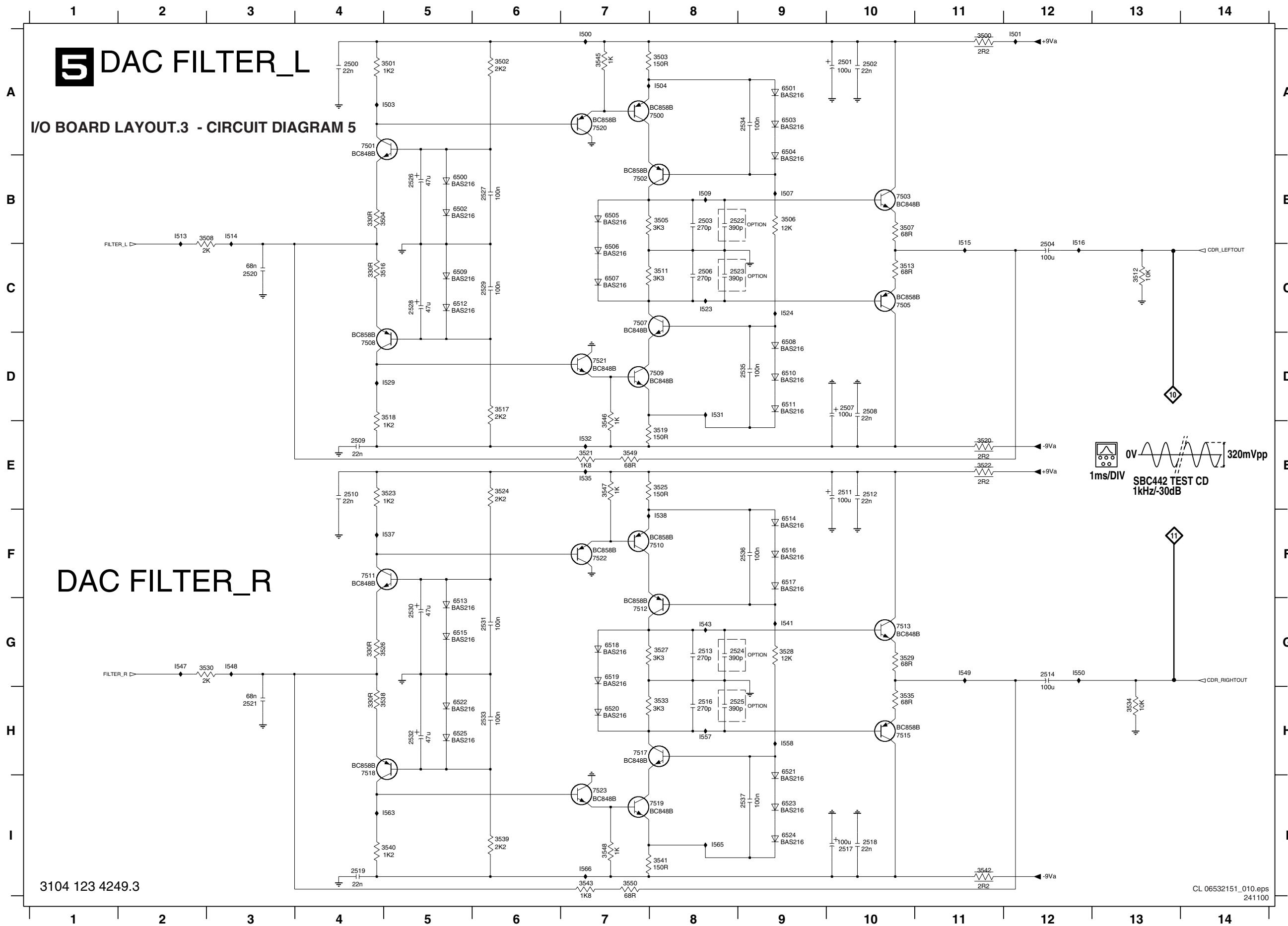

- 2500 A4
- 2501 A10
- 2502 A10
- 2503 B8
- 2504 C12
- 2506 C8
- 2507 D10
- 2508 D10
- 2509 E4
- 2510 E4
- 2511 E10
- 2512 E10
- 2513 G8
- 2514 G12
- 2516 H8
- 2517 H10
- 2518 H10
- 2519 I4
- 2520 C3
- 2521 H3
- 2522 B8
- 2523 C8
- 2524 G8
- 2525 H8
- 2526 B5
- 2527 B6
- 2528 C5
- 2529 C6
- 2530 G5
- 2531 G6
- 2532 H5
- 2533 H6
- 2534 A9
- 2535 D9
- 2536 F9
- 2537 I9
- 3500 A11
- 3501 A5
- 3502 A6
- 3503 A8
- 3504 B5
- 3505 B8
- 3506 B9
- 3507 B10
- 3508 B2
- 3511 C8
- 3512 C13
- 3513 C10
- 3516 C4
- 3517 D6
- 3518 D5
- 3519 E8
- 3520 E11
- 3521 E7
- 3522 E11
- 3523 E5
- 3524 E6
- 3525 E8
- 3526 G5
- 3527 G8
- 3528 G9
- 3529 G10
- 3530 G2
- 3533 H8
- 3534 H13
- 3535 H10
- 3538 H4
- 3539 I6
- 3540 I5
- 3541 I8
- 3542 I11
- 3543 I7
- 3545 A7
- 3546 E7
- 3547 E7
- 3548 I7
- 3549 E7
- 3550 I7
- 6500 B5
- 6501 A9
- 6502 B5
- 6503 A9
- 6504 A9
- 6505 B7
- 6506 C7
- 6507 C7
- 6508 D9
- 6509 C5
- 6510 D9
- 6511 D9
- 6512 C5
- 6513 G5
- 6514 F9
- 6515 G5
- 6516 F9
- 6517 F9
- 6518 G7
- 6519 G7
- 6520 H7
- 6521 H9
- 6522 H5
- 6523 I9
- 6524 I9
- 6525 H5
- 7500 A8
- 7501 A4
- 7502 B7
- 7503 B10
- 7505 C10
- 7507 C7
- 7508 D4
- 7509 D8
- 7510 F8
- 7511 F4
- 7512 G7
- 7513 G10
- 7515 H10
- 7517 H7
- 7518 H4
- 7519 I8
- 7520 A7
- 7521 D7
- 7522 F7
- 7523 I7
- I500 A7
- I501 A12
- I503 A5
- I504 A8
- I507 B9
- I509 B8
- I513 B2
- I514 B3
- I515 B11
- I516 B12
- I523 C8
- I524 C9
- I529 D5
- I531 D8
- I532 E7
- I535 E7
- I537 F5
- I538 F8
- I541 G9
- I543 G8
- I547 G2
- I548 G3
- I549 G11
- I550 G12
- I557 H8
- I558 H9
- I563 I5
- I565 I8
- I566 I7



3104 123 4249.3

CL 06532151_010.eps 241100

I/O board: DAC

6 DAC

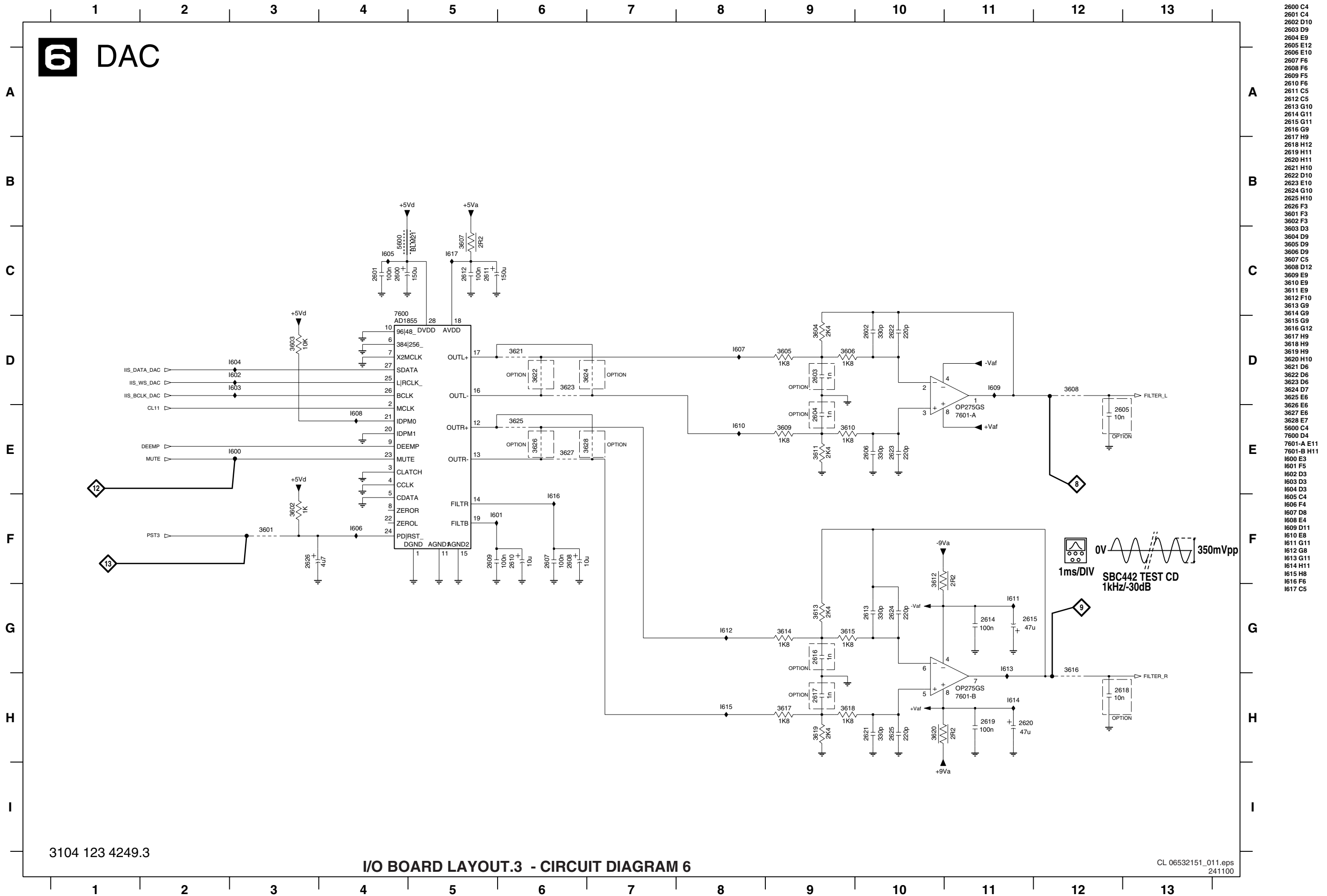

- 2600 C4
- 2601 C4
- 2602 D10
- 2603 D9
- 2604 E9
- 2605 E12
- 2606 E10
- 2607 F6
- 2608 F6
- 2609 F5
- 2610 F6
- 2611 C5
- 2612 C5
- 2613 G10
- 2614 G11
- 2615 G11
- 2616 G9
- 2617 H9
- 2618 H12
- 2619 H11
- 2620 H11
- 2621 H10
- 2622 D10
- 2623 E10
- 2624 G10
- 2625 H10
- 2626 F3
- 3601 F3
- 3602 F3
- 3603 D3
- 3604 D9
- 3605 D9
- 3606 D9
- 3607 C5
- 3608 D12
- 3609 E9
- 3610 E9
- 3611 E9
- 3612 F10
- 3613 G9
- 3614 G9
- 3615 G9
- 3616 G12
- 3617 H9
- 3618 H9
- 3619 H9
- 3620 H10
- 3621 D6
- 3622 D6
- 3623 D6
- 3624 D7
- 3625 E6
- 3626 E6
- 3627 E6
- 3628 E7
- 5600 C4
- 7600 D4
- 7601-A E11
- 7601-B H11
- I600 E3
- I601 F5
- I602 D3
- I603 D3
- I604 D3
- I605 C4
- I606 F4
- I607 D8
- I608 E4
- I609 D11
- I610 E9
- I611 G11
- I612 G8
- I613 G11
- I614 H11
- I615 H8
- I616 F6
- I617 C5

3104 123 4249.3

I/O BOARD LAYOUT.3 - CIRCUIT DIAGRAM 6

CL 06532151_011.eps
241100

Layout I/O board

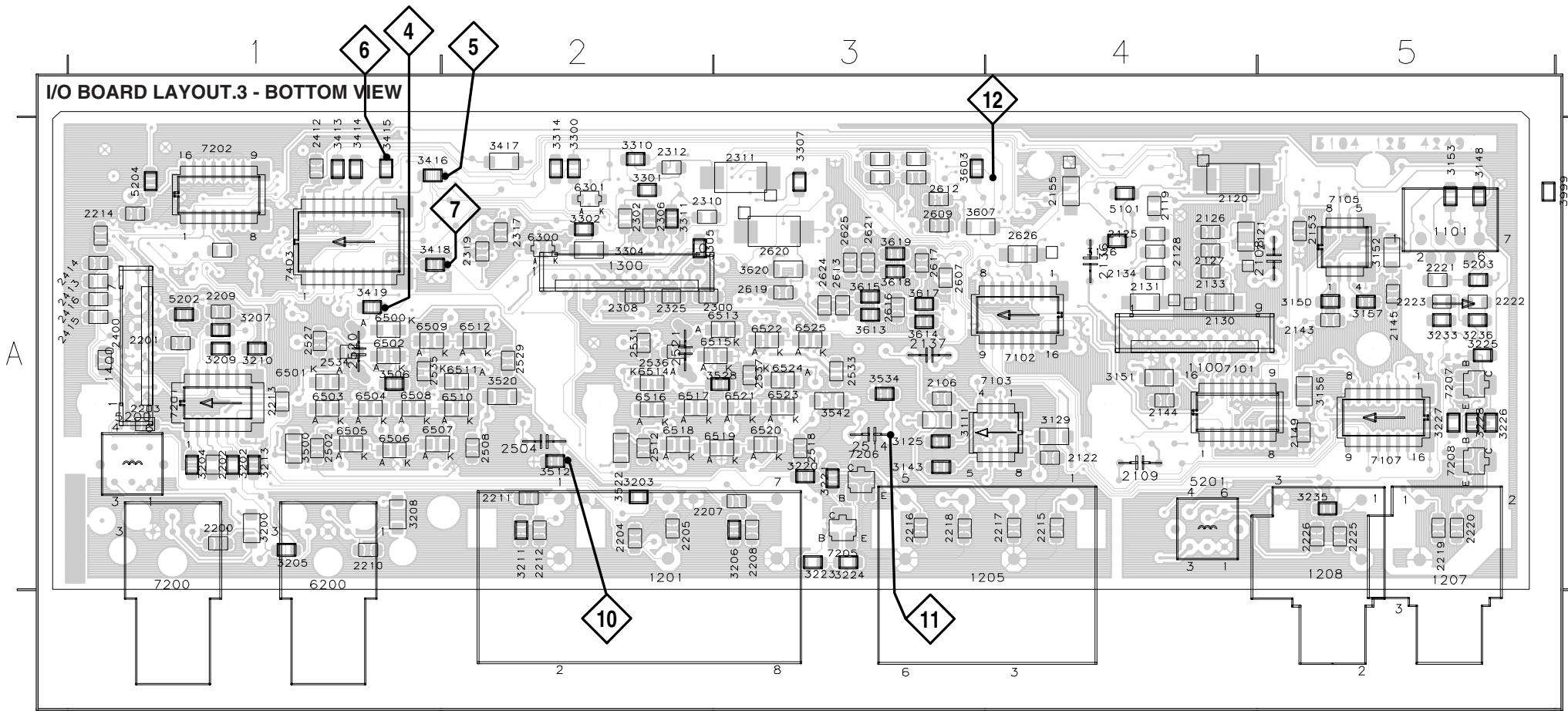

2214	5204	7202	3207	6500	6502	6503	6504	6505	6506	6507	6508	6509	6510	6511	6512	6513	6514	6515	6516	6517	6518	6519	6520	6521	6522	6523	6524	6525	6526	6527	6528	6529	6530	6531	6532	6533	6534	6535	6536	6537	6538	6539	6540	6541	6542	6543	6544	6545	6546	6547	6548	6549	6550	6551	6552	6553	6554	6555	6556	6557	6558	6559	6560	6561	6562	6563	6564	6565	6566	6567	6568	6569	6570	6571	6572	6573	6574	6575	6576	6577	6578	6579	6580	6581	6582	6583	6584	6585	6586	6587	6588	6589	6590	6591	6592	6593	6594	6595	6596	6597	6598	6599	6600
------	------	------	------	------	------	------	------	------	------	------	------	------	------	------	------	------	------	------	------	------	------	------	------	------	------	------	------	------	------	------	------	------	------	------	------	------	------	------	------	------	------	------	------	------	------	------	------	------	------	------	------	------	------	------	------	------	------	------	------	------	------	------	------	------	------	------	------	------	------	------	------	------	------	------	------	------	------	------	------	------	------	------	------	------	------	------	------	------	------	------	------	------	------	------	------	------	------	------	------	------	------	------	------

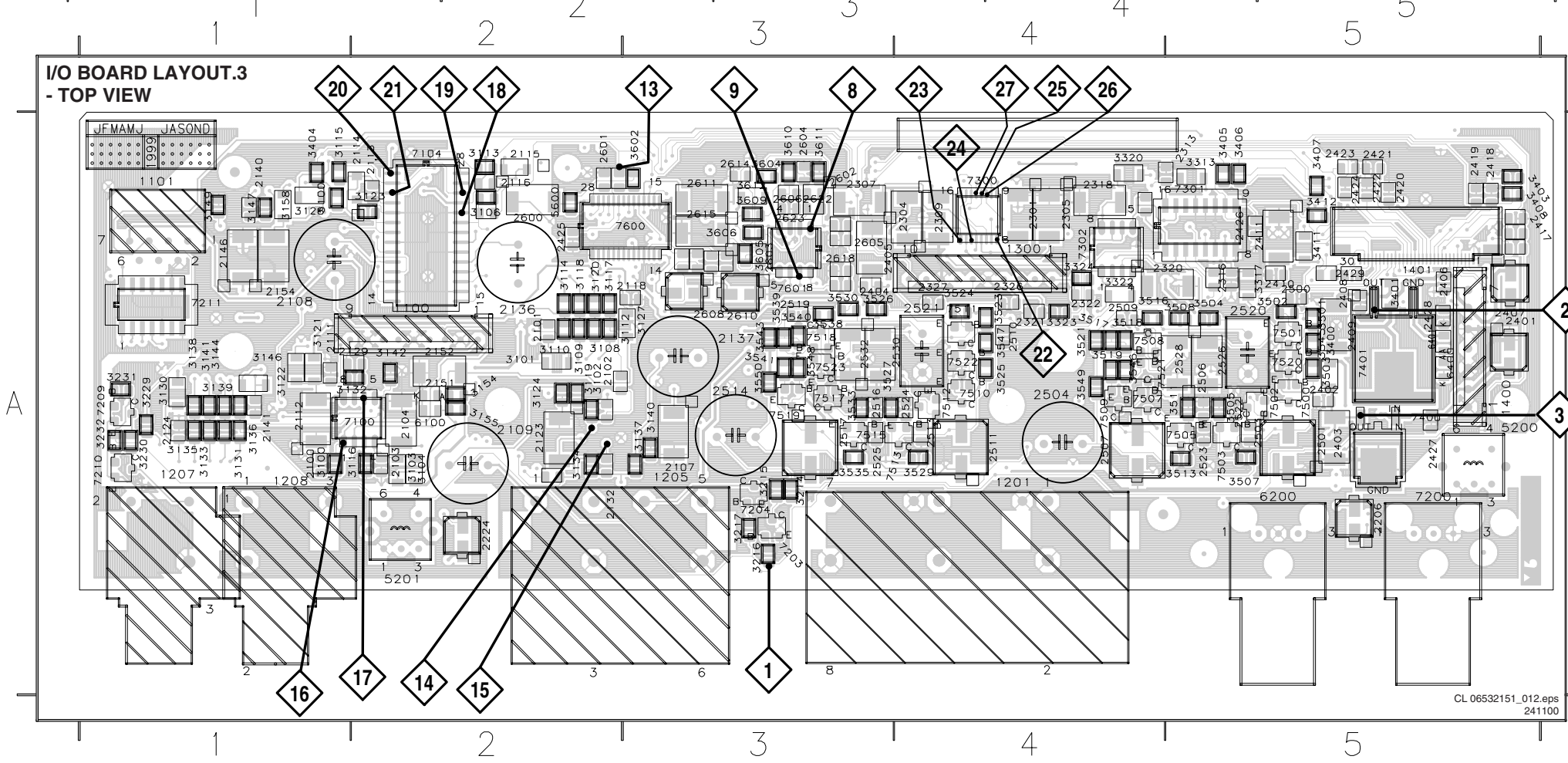

1101	3229	3130	3131	3132	3133	3134	3135	3136	3137	3138	3139	3140	3141	3142	3143	3144	3145	3146	3147	3148	3149	3150	3151	3152	3153	3154	3155	3156	3157	3158	3159	3160	3161	3162	3163	3164	3165	3166	3167	3168	3169	3170	3171	3172	3173	3174	3175	3176	3177	3178	3179	3180	3181	3182	3183	3184	3185	3186	3187	3188	3189	3190	3191	3192	3193	3194	3195	3196	3197	3198	3199	3200	3201	3202	3203	3204	3205	3206	3207	3208	3209	3210	3211	3212	3213	3214	3215	3216	3217	3218	3219	3220	3221	3222	3223	3224	3225	3226	3227	3228	3229	3230	3231	3232	3233	3234	3235	3236	3237	3238	3239	3240	3241	3242	3243	3244	3245	3246	3247	3248	3249	3250	3251	3252	3253	3254	3255	3256	3257	3258	3259	3260	3261	3262	3263	3264	3265	3266	3267	3268	3269	3270	3271	3272	3273	3274	3275	3276	3277	3278	3279	3280	3281	3282	3283	3284	3285	3286	3287	3288	3289	3290	3291	3292	3293	3294	3295	3296	3297	3298	3299	3300
------	------	------	------	------	------	------	------	------	------	------	------	------	------	------	------	------	------	------	------	------	------	------	------	------	------	------	------	------	------	------	------	------	------	------	------	------	------	------	------	------	------	------	------	------	------	------	------	------	------	------	------	------	------	------	------	------	------	------	------	------	------	------	------	------	------	------	------	------	------	------	------	------	------	------	------	------	------	------	------	------	------	------	------	------	------	------	------	------	------	------	------	------	------	------	------	------	------	------	------	------	------	------	------	------	------	------	------	------	------	------	------	------	------	------	------	------	------	------	------	------	------	------	------	------	------	------	------	------	------	------	------	------	------	------	------	------	------	------	------	------	------	------	------	------	------	------	------	------	------	------	------	------	------	------	------	------	------	------	------	------	------	------	------	------	------	------	------	------	------	------	------	------

PSU CDR3-ECU

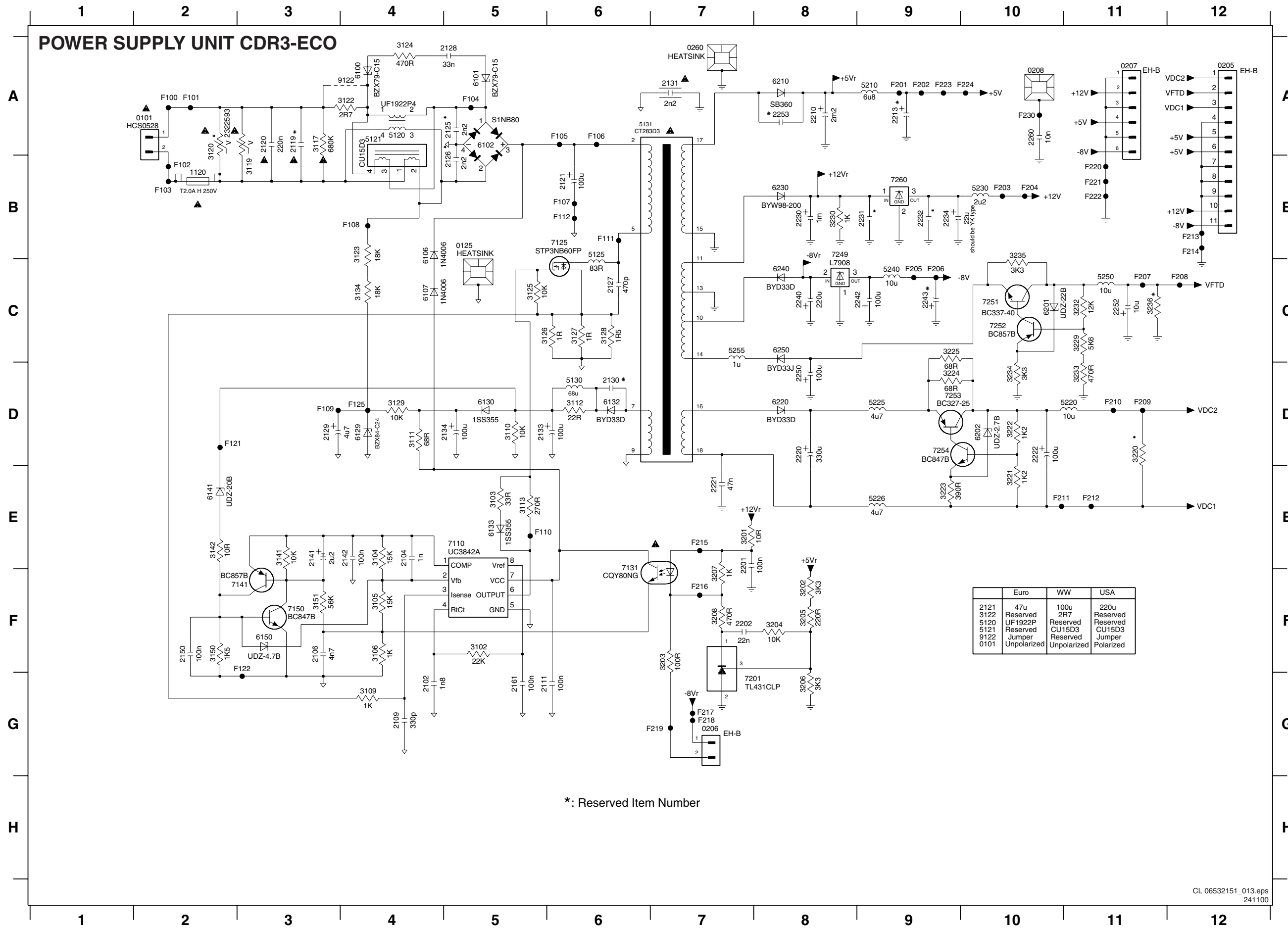

*: Reserved Item Number

	Euro	WW	USA
2121	47u	100u	220u
3122	Reserved	2R7	Reserved
5120	UF1922P	Reserved	Reserved
5121	Reserved	CU15D3	CU15D3
9122	Jumper	Reserved	Jumper
0101	Unpolarized	Unpolarized	Polarized

- 0101 A2
- 0125 B5
- 0205 A12
- 0206 G7
- 0207 A11
- 0208 A10
- 0260 A7
- 1120 B2
- 2102 G4
- 2104 E4
- 2106 F3
- 2109 G4
- 2111 G5
- 2119 A3
- 2120 A3
- 2121 B6
- 2125 A5
- 2126 B5
- 2127 C6
- 2128 A5
- 2129 D3
- 2130 D6
- 2131 A7
- 2133 D5
- 2134 D5
- 2141 E3
- 2142 E4
- 2150 F2
- 2161 G5
- 2201 E7
- 2202 F7
- 2210 A8
- 2213 A9
- 2220 D8
- 2221 E7
- 2222 D10
- 2230 B8
- 2231 B9
- 2232 B9
- 2234 B9
- 2240 C8
- 2242 C9
- 2243 C9
- 2250 D8
- 2252 C11
- 2253 A8
- 2260 A10
- 3102 F5
- 3103 E5
- 3104 E4
- 3105 F4
- 3106 F4
- 3109 G4
- 3110 D5
- 3111 D4
- 3112 D6
- 3113 E5
- 3117 A3
- 3119 B3
- 3120 A2
- 3122 A4
- 3123 B4
- 3124 A4
- 3125 C5
- 3126 C6
- 3127 C6
- 3128 C6
- 3129 D4
- 3134 C4
- 3141 E3
- 3142 E2
- 3150 F2
- 3151 F3
- 3201 E7
- 3202 F8
- 3203 F7
- 3204 F8
- 3205 F8
- 3206 G8
- 3207 F7
- 3208 F7
- 3220 D11
- 3221 E10
- 3222 D10
- 3223 E9
- 3224 D9
- 3225 C9
- 3229 C11
- 3230 B8
- 3232 C11
- 3233 D11
- 3234 D10
- 3235 B10
- 3236 C11
- 5120 A4
- 5121 A4
- 5125 B6
- 5130 D6
- 5131 A6
- 5210 A9
- 5220 D11
- 5225 D9
- 5226 E9
- 5230 B10
- 5240 C9
- 5250 C11
- 6100 A4
- 6101 A5
- 6102 A5
- 6106 B4
- 6107 C4
- 6129 D4
- 6130 D5
- 6132 D6
- 6133 E5
- 6141 E2
- 6150 F3
- 6201 C10
- 6202 D10
- 6210 A8
- 6220 D8
- 6230 B8
- 6240 C8
- 6250 C8
- 7105 E5
- 7125 B6
- 7131 F6
- 7141 F3
- 7150 F3
- 7201 G7
- 7249 B8
- 7251 C10
- 7252 C10
- 7253 D9
- 7254 D9
- 7260 B9
- 9122 A4
- F100 A2
- F101 A2
- F102 B2
- F104 A5
- F105 A6
- F106 A6
- F107 B6
- F109 A3
- F120 B10
- F201 A9
- F202 A9
- F203 B10
- F204 B10
- F205 C9
- F206 C9
- F207 C11
- F208 C12
- F209 D11
- F210 D11
- F211 E10
- F212 E11
- F213 B12
- F214 B12
- F215 E7
- F216 F7
- F217 G7
- F218 G7
- F219 G7
- F220 B11
- F221 B11
- F222 B11
- F223 A9
- F224 A10
- F230 G8
- F231 A10

Layout PSU CDR3-ECO

0101 C3	1120 C2	2128 A4	2210 B9	2242 C9	3112 C6	3126 B4	3208 D8	5125 B5	5230 C11	6106 A5	6250 D8	7253 A10	9206 B11
0125 B5	2119 D1	2130 C5	2213 A10	2243 C9	3117 C6	3127 B4	3209 A11	5126 B5	5231 C11	6107 A5	6251 D8	7254 A10	9207 D11
0205 B5	2120 C1	2131 C6	2220 A10	2244 C9	3120 C6	3128 B4	3208 D8	5127 B5	5232 C11	6108 A5	6252 D8	7255 A10	9208 A11
0206 D9	2121 A5	2132 C6	2221 A10	2245 C9	3121 C6	3129 B4	3209 A11	5128 B5	5233 C11	6109 A5	6253 D8	7256 A10	
0207 D11	2122 A4	2133 C6	2222 A10	2246 C9	3122 C6	3130 B4	3210 D8	5129 B5	5234 C11	6110 A5	6254 D8	7257 A10	
0208 A11	2123 B4	2134 C6	2223 A10	2247 C9	3123 C6	3131 B4	3211 D8	5130 B5	5235 C11	6111 A5	6255 D8	7258 A10	
0260 B11	2127 A5	2141 C4	2240 D8	3111 C5	3124 C6	3134 B4	3212 D8	5131 B5	5236 C11	6112 A5	6256 D8	7259 A10	

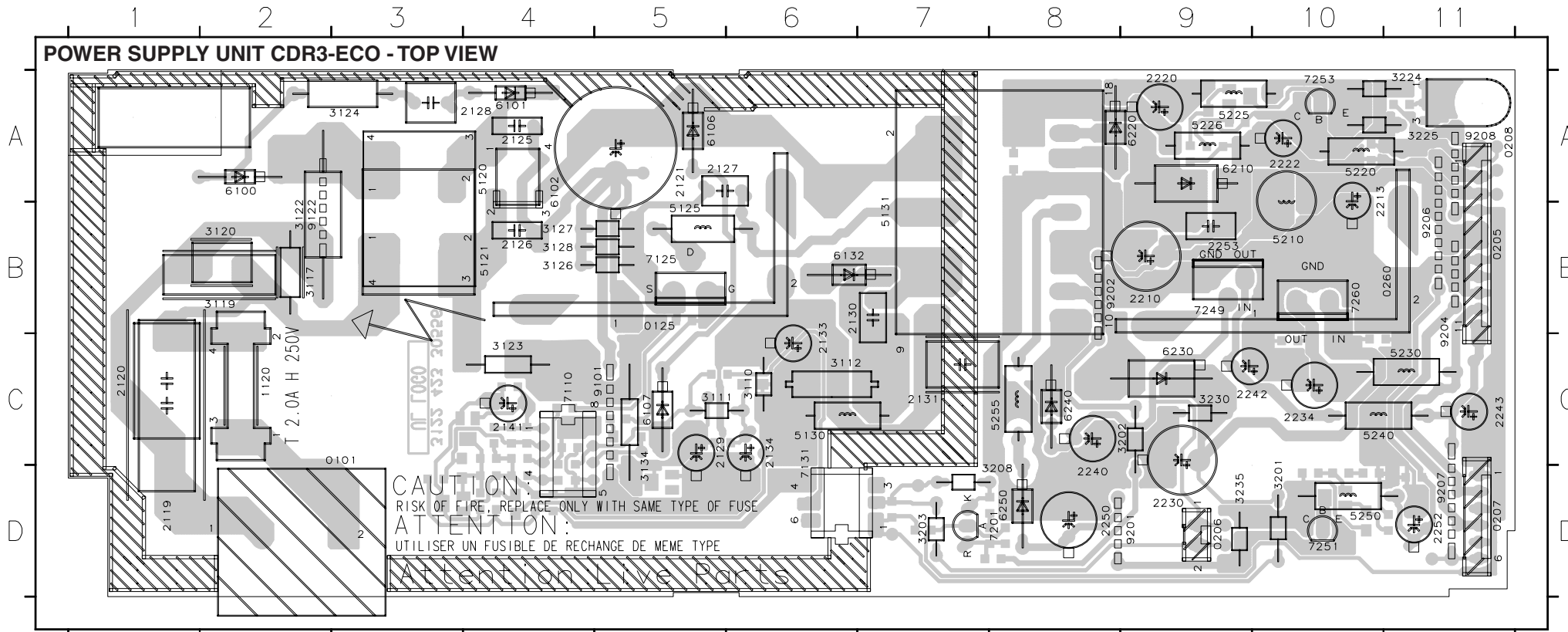

2102 A4	2111 A4	2201 A7	2232 B10	3104 B4	3113 B5	3142 A4	3205 A8	3221 D9	3232 A10	4101 B5	6141 A4	7141 B4
2104 B4	2142 B4	2202 A8	2260 D11	3105 A3	3114 B5	3150 B4	3206 A8	3222 D9	3233 A10	4102 B5	6150 A3	7150 A3
2106 A4	2150 A4	2221 D8	3102 A4	3106 A4	3125 B5	3151 A4	3207 A7	3223 D9	3234 A11	4103 B5	6201 A10	7252 A10
2109 B4	2161 B4	2231 B10	3103 B5	3109 B4	3141 B4	3204 A8	3220 D10	3229 A10	3236 A11	4104 B5	6202 D9	7254 D9

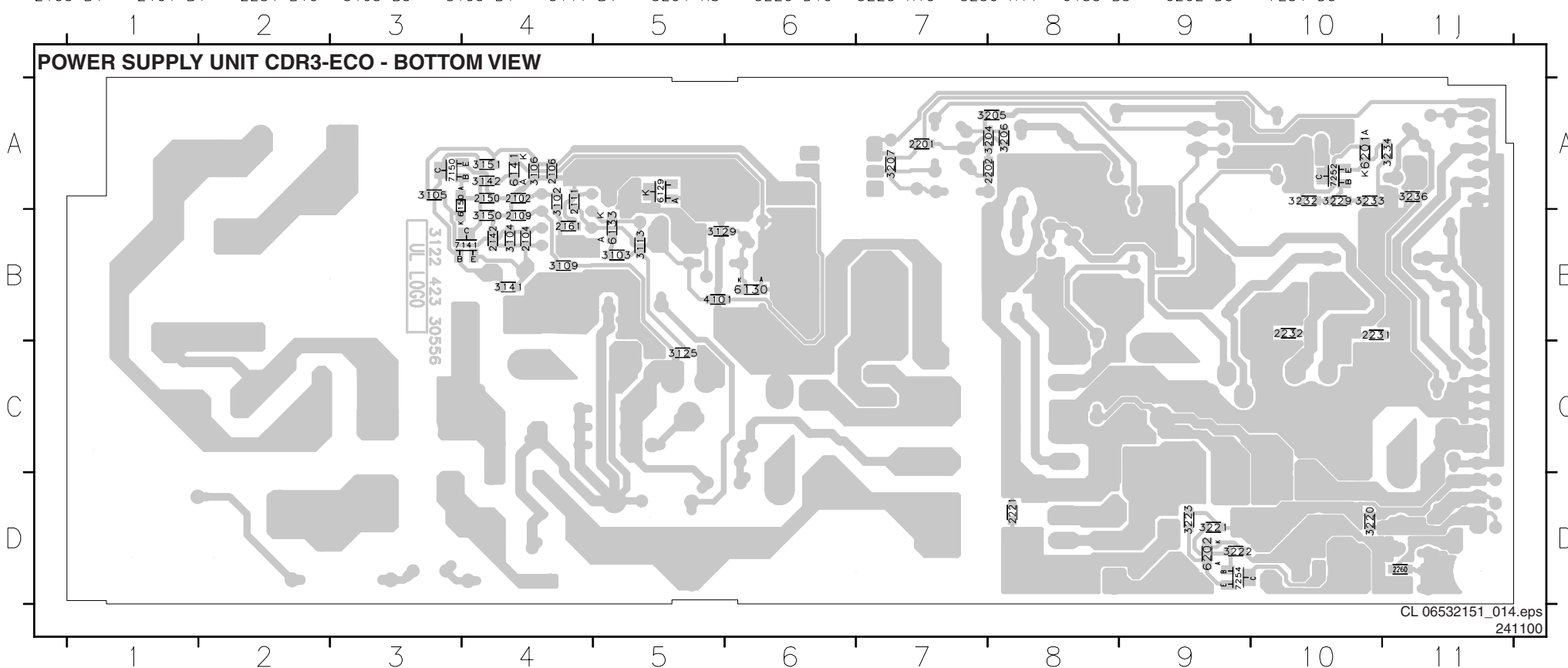

CD main board: Decoder & servo processor part

1000-1 C1	1000-7 H1	1020 G10	2130 B6	2139 B11	2148 C1	2159 D1	2169 F8	2183 F3	2232 H13	3164 B15	3176 C8	3187 D2	3196 E6	3205 E7	3219-C G13	3269 H14	3282 G11	7006 D3	7130 H15	F151 C13	F164 D7	F174 E7	F190 H14	F309 C9	F321 G12
1000-10 G1	1000-8 H1	1021 G10	2130 B6	2139 B11	2148 C1	2159 D1	2169 F8	2183 F3	2232 H13	3164 B15	3176 C8	3187 D2	3196 E6	3205 E7	3219-D G13	3270 H15	3283 G12	7007 E7	7131 H14	F154 C1	F165 D13	F175 E7	F191 H11	F310 C9	F322 G12
1000-11 G1	1000-9 H1	1022 G11	2131 B12	2140 C4	2149 C6	2160 D6	2170 F9	2184 G9	2233 H13	3168 B12	3179 C1	3188 D5	3197 E8	3206 E8	3220 G11	3273 H15	3284 D13	7008 E2	7132 H13	F155 C2	F166 E7	F177 F1	F192 H14	F311 D13	F324 G10
1000-12 D1	1003 F7	1023 G11	2132 B11	2141 C6	2150 D9	2162 E4	2172 F9	2185 G10	2280 F14	3171 B13	3181 C9	3190 D9	3199 E3	3211 F6	3225 H12	3274 B12	3285 H13	7009 D5	7131-A G2	F156 C8	F167 E14	F178 F9	F302 B12	F312 D9	
1000-2 E1	1004 G9	1028 B2	2133 B1	2142 C9	2152 D3	2163 E1	2173 F9	2189 G9	2285 G10	3172 B11	3182 D2	3191 D4	3200 E8	3212 F9	3229 H9	3275 B12	3286 H13	7010 E6	F159 A13	F168 C3	F179 G1	F180 G1	F303 B11	F313 D7	
1000-3 B1	1009 C15	1029 B3	2134 B1	2143 C4	2154 D9	2164 E4	2174 F1	2191 H9	2286 G11	3173 B4	3183 D2	3192 D4	3201 E2	3213 F3	3225 H10	3276 B11	3287 H13	7011 E2	F143 A3	F159 C9	F170 E1	F181 F13	F304 B11	F314 D9	
1000-4 E1	1010 C15	1050-1 G1	2135 B1	2145 C9	2155 D9	2166 E3	2175 F2	2200 H4	3160 A9	3174 B4	3184 D8	3193 D7	3202 E2	3214 F14	3226 H14	3279 B2	6003 H14	7023 B5	F146 A2	F160 D1	F171 E7	F182 G13	F305 B11	F315 D13	
1000-5 A1	1011 C15	1050-2 G1	2137 B8	2146 C6	2156 D2	2167 E14	2178 G10	2201 H4	3161 B12	3176 C14	3185 D14	3194 D8	3203 E5	3219-A G13	3227 H13	3280 F13	7000 C9	7024 F6	F147 B1	F162 D7	F172 E14	F183 G12	F306 B12	F316 D13	
1000-6 H1	1012 C15	2128 B12	2138 B8	2147 C1	2157 D8	2168 F8	2182 F3	2230 H14	3162 B11	3177 C2	3186 D14	3195 E8	3204 E8	3219-B G13	3228 H14	3281 F6	7005-B B14	7025 B7	F149 B13	F163 D14	F173 E1	F184 G11	F308 B11	F319 G9	

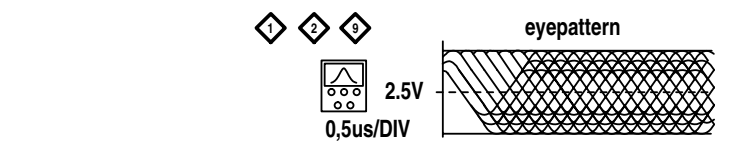
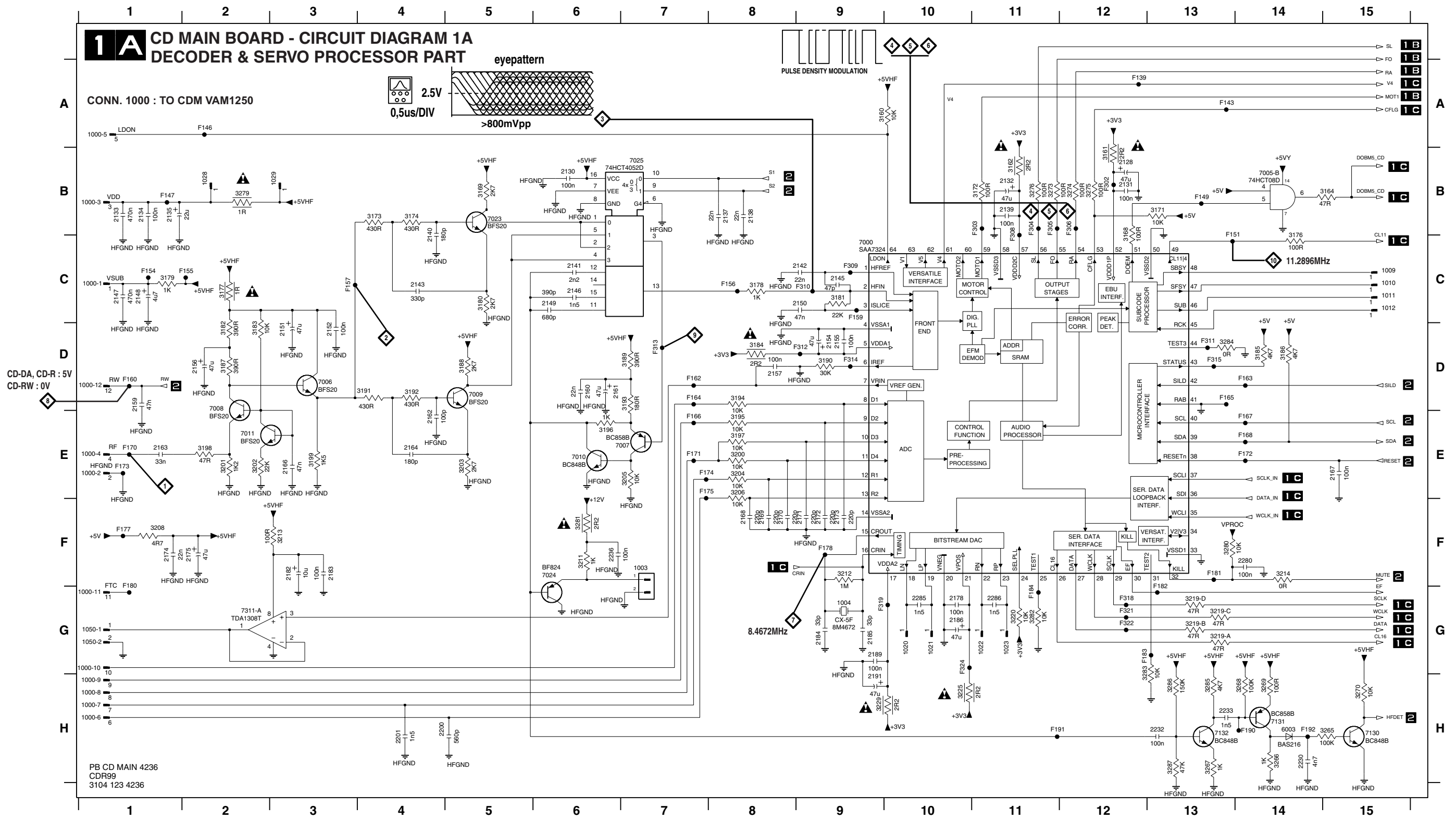

CD main board: Servo drivers part

1 B CD MAIN BOARD - CIRCUIT DIAGRAM 1B
SERVO DRIVERS PART

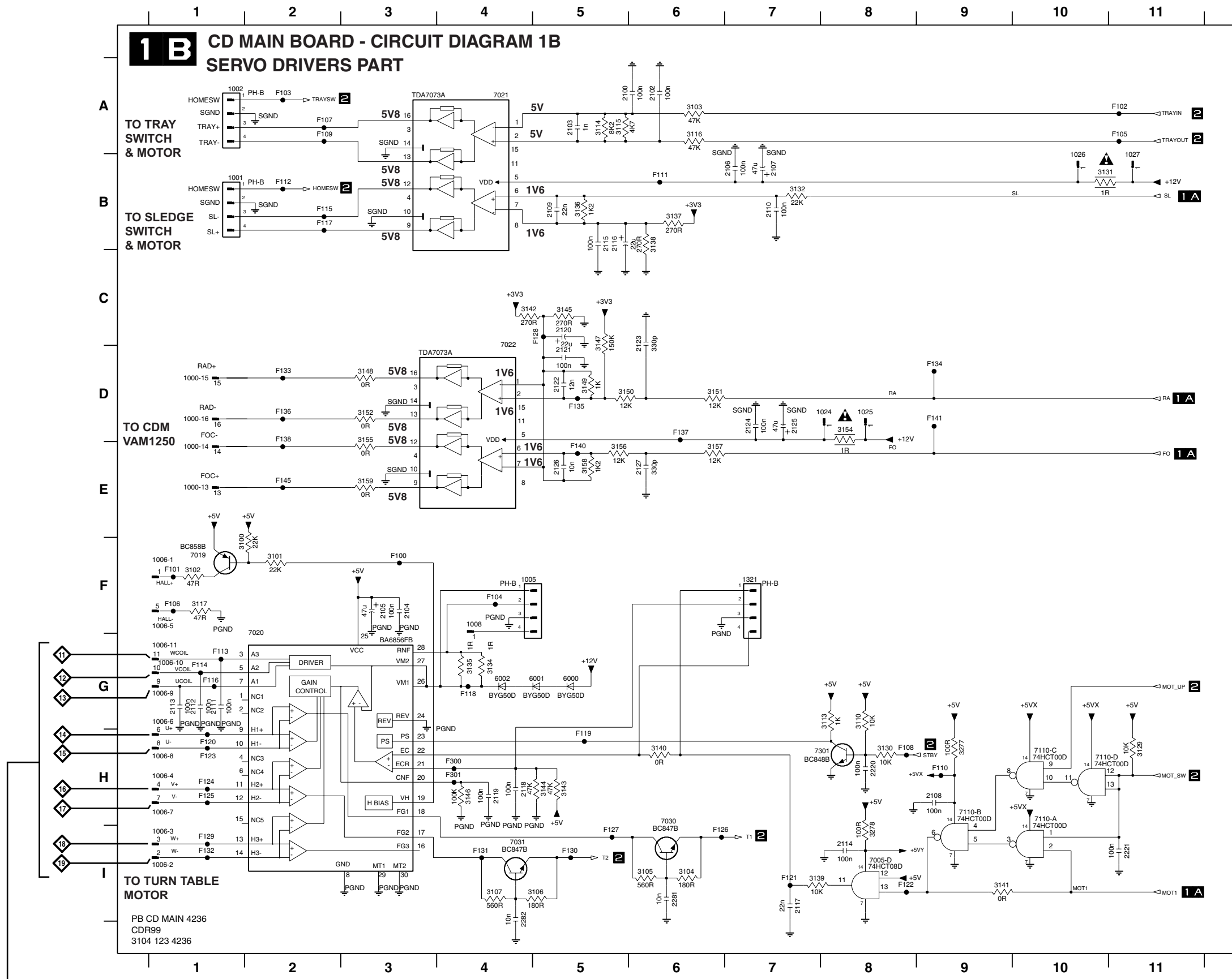

- 1000-13 E1
- 1000-14 E1
- 1000-15 D1
- 1000-16 D1
- 1001 B1
- 1002 A1
- 1002 F5
- 1006-1 F1
- 1006-10 G1
- 1006-11 G1
- 1006-2 I1
- 1006-3 I1
- 1006-4 H1
- 1006-5 F1
- 1006-6 G1
- 1006-7 H1
- 1006-8 H1
- 1006-9 G1
- 1008 F4
- 1024 D8
- 1025 D8
- 1026 B10
- 1027 B11
- 1321 F7
- 2100 A5
- 2102 A6
- 2103 A5
- 2104 F3
- 2105 C3
- 2106 B7
- 2107 B7
- 2108 H9
- 2109 B5
- 2110 B7
- 2111 G1
- 2112 G1
- 2113 G1
- 2114 I8
- 2115 B5
- 2116 B5
- 2117 I7
- 2118 H4
- 2119 H4
- 2120 C5
- 2121 D5
- 2122 D5
- 2123 C6
- 2124 D7
- 2125 D7
- 2126 E5
- 2127 E6
- 2220 H8
- 2221 I11
- 2281 I6
- 2282 I4
- 3100 F1
- 3101 F2
- 3102 F1
- 3103 A6
- 3104 I6
- 3105 I6
- 3106 I5
- 3107 I4
- 3110 G8
- 3113 G8
- 3114 A5
- 3115 A5
- 3116 A6
- 3117 F1
- 3129 H11
- 3130 H8
- 3131 B10
- 3132 B7
- 3134 G4
- 3135 G4
- 3136 B5
- 3137 B6
- 3138 B6
- 3139 I7
- 3140 H6
- 3141 I9
- 3142 C4
- 3143 H5
- 3144 H5
- 3145 C5
- 3146 H4
- 3147 C5
- 3148 D3
- 3149 D5
- 3150 D5
- 3151 D6
- 3152 D3
- 3154 D8
- 3155 E3
- 3156 E5
- 3157 E6
- 3158 E5
- 3159 E3
- 3277 H9
- 3278 I8
- 6000 G5
- 6001 G5
- 6002 G4
- 7005-1 B
- 7019 F1
- 7020 G2
- 7021 A4
- 7022 D4
- 7030 H6
- 7031 I4
- 7110-A H10
- 7110-B H9
- 7110-C H10
- 7110-D H11
- 7301 H8
- F100 F3
- F101 F1
- F102 A11
- F103 A2
- F104 F4
- F105 A11
- F106 F1
- F107 A2
- F108 H8
- F109 A2
- F110 H9
- F111 B6
- F112 B2
- F113 G1
- F114 G1
- F115 B2
- F116 G1
- F117 B2
- F118 G4
- F119 H5
- F120 H1
- F121 I7
- F122 I8
- F123 H1
- F124 H1
- F125 H1
- F126 I6
- F127 I5
- F128 C5
- F129 I1
- F130 I5
- F131 I4
- F132 I1
- F133 D2
- F134 D9
- F135 D5
- F136 D2
- F137 D6
- F138 D2
- F140 E5
- F141 D9
- F145 E2
- F300 H4
- F301 H4

Input conditions conn 1006 pin						Outputs conn 1006			Test points on driver		
6	8	4	7	3	2	9	10	11	18	17	16
U+	U-	V+	V-	W+	W-	UCOIL	VCOIL	WCOIL	HALL U	HALL V	HALL W
L	M	H	M	M	M	6V	0V	0V	0V	5V	
H	M	L	M	M	M	0V	6V	6V	5V	0V	
M	M	L	M	H	M	0V	6V	0V	0V	0V	5V
M	M	H	M	L	M	6V	0V	6V	5V	0V	0V
H	M	M	M	L	M	0V	0V	6V	5V	0V	0V
L	M	M	M	H	M	6V	6V	0V	0V	5V	0V

Input voltage	Level	Tolerance	Unit
H	2.8	0.1	V
M	2.5	0.1	V
L	2.2	0.1	V

CD main board: Audio part



CD MAIN BOARD - CIRCUIT DIAGRAM 1C
AUDIO PART

CONN. 1208 : TO CDR MAIN BOARD
CONN. 1209 : TO CD OUT BOARD

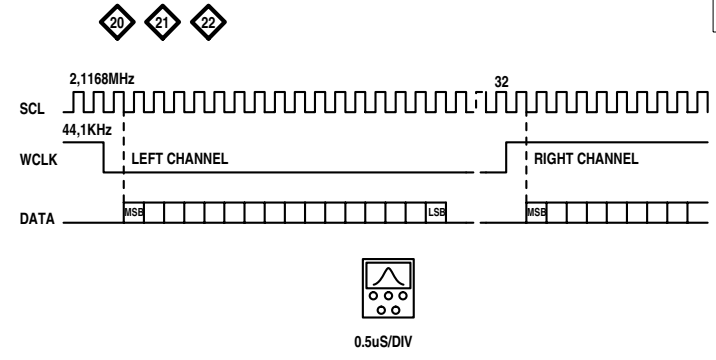
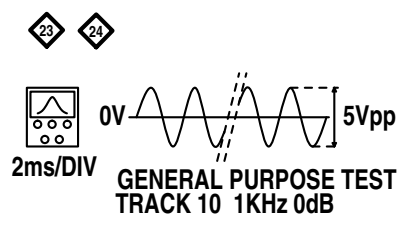
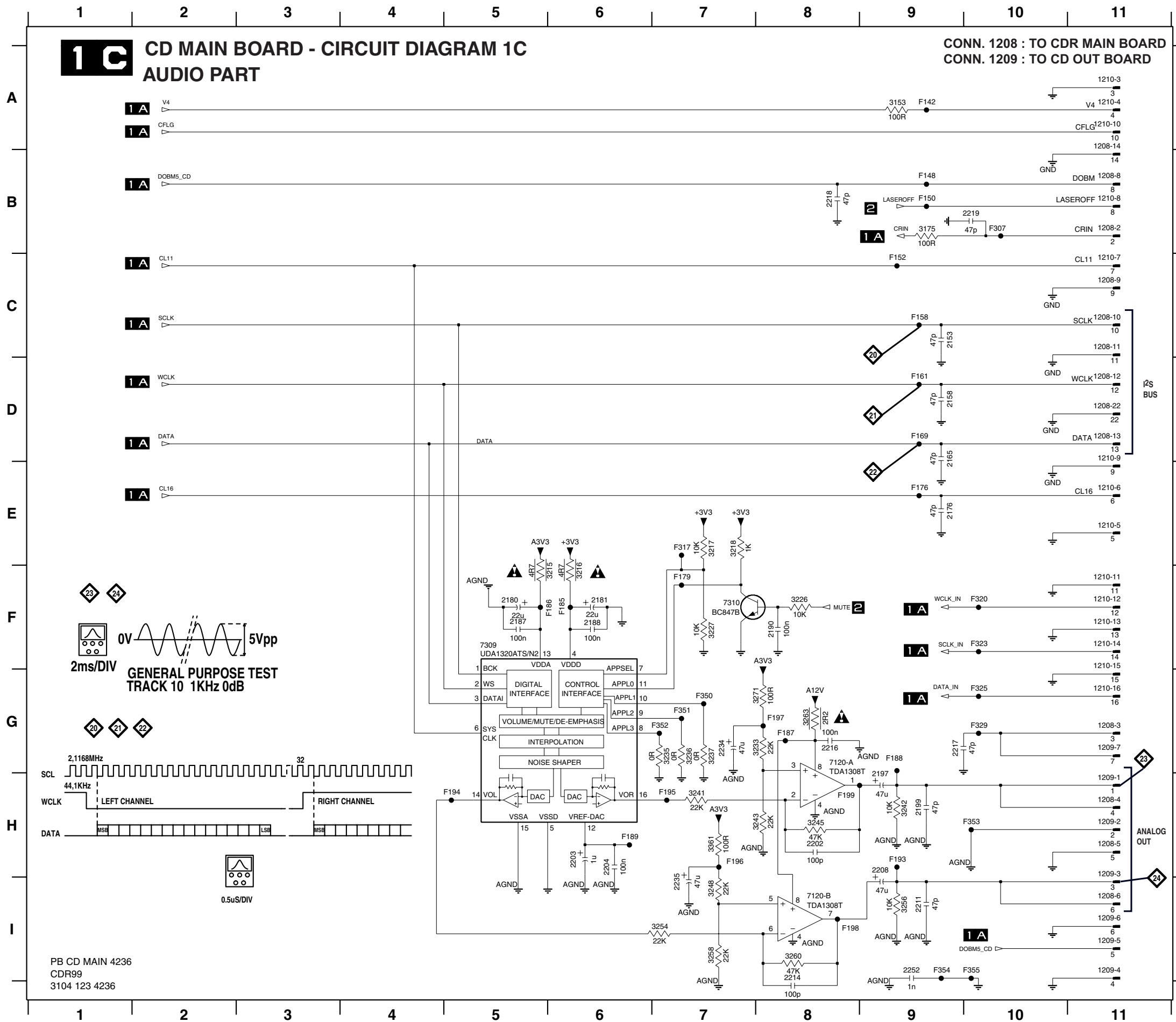

PB CD MAIN 4236
CDR99
3104 123 4236

- 1208-10 C11
- 1208-11 C11
- 1208-12 D11
- 1208-13 D11
- 1208-14 A11
- 1208-2 B11
- 1208-22 D11
- 1208-3 G11
- 1208-4 H11
- 1208-5 H11
- 1208-6 I11
- 1208-8 B11
- 1208-9 C11
- 1209-1 H11
- 1209-2 H11
- 1209-3 H11
- 1209-4 I11
- 1209-6 I11
- 1209-7 G11
- 1210-10 A11
- 1210-11 F11
- 1210-12 F11
- 1210-13 F11
- 1210-14 F11
- 1210-15 F11
- 1210-16 G11
- 1210-3 A11
- 1210-4 A11
- 1210-5 E11
- 1210-6 E11
- 1210-7 C11
- 1210-8 B11
- 1210-9 D11
- 2153 C9
- 2158 D9
- 2165 D9
- 2176 E9
- 2180 F5
- 2181 F6
- 2187 F5
- 2188 F6
- 2190 F8
- 2197 H9
- 2199 H9
- 2202 H8
- 2203 H6
- 2204 H6
- 2208 H9
- 2211 I9
- 2214 I8
- 2216 G8
- 2217 G9
- 2218 B8
- 2219 B10
- 2234 G7
- 2235 I7
- 2252 I9
- 3153 A9
- 3175 B9
- 3215 F5
- 3216 F6
- 3217 E7
- 3218 E7
- 3226 F8
- 3227 F7
- 3233 G8
- 3235 G7
- 3236 G7
- 3237 G7
- 3241 H7
- 3242 H9
- 3243 H8
- 3245 H8
- 3248 I7
- 3254 I7
- 3256 I9
- 3258 I7
- 3260 I8
- 3263 G8
- 3271 G8
- 3361 H7
- 7120-A G8
- 7120-B I8
- 7309 F5
- 7310 F7
- F142 A9
- F148 B9
- F150 B9
- F152 C9
- F158 C9
- F161 D9
- F169 D9
- F185 D9
- F186 D9
- F187 D9
- F188 D9
- F189 D9
- F193 D9
- F196 H7
- F197 G8
- F198 H8
- F199 H8
- F307 B10
- F317 E7
- F320 F10
- F323 F10
- F325 F10
- F326 F10
- F327 F10
- F329 F10
- F350 G7
- F351 G7
- F352 G7
- F353 H10
- F354 I9
- F355 I10

CD main board: Microprocessor part

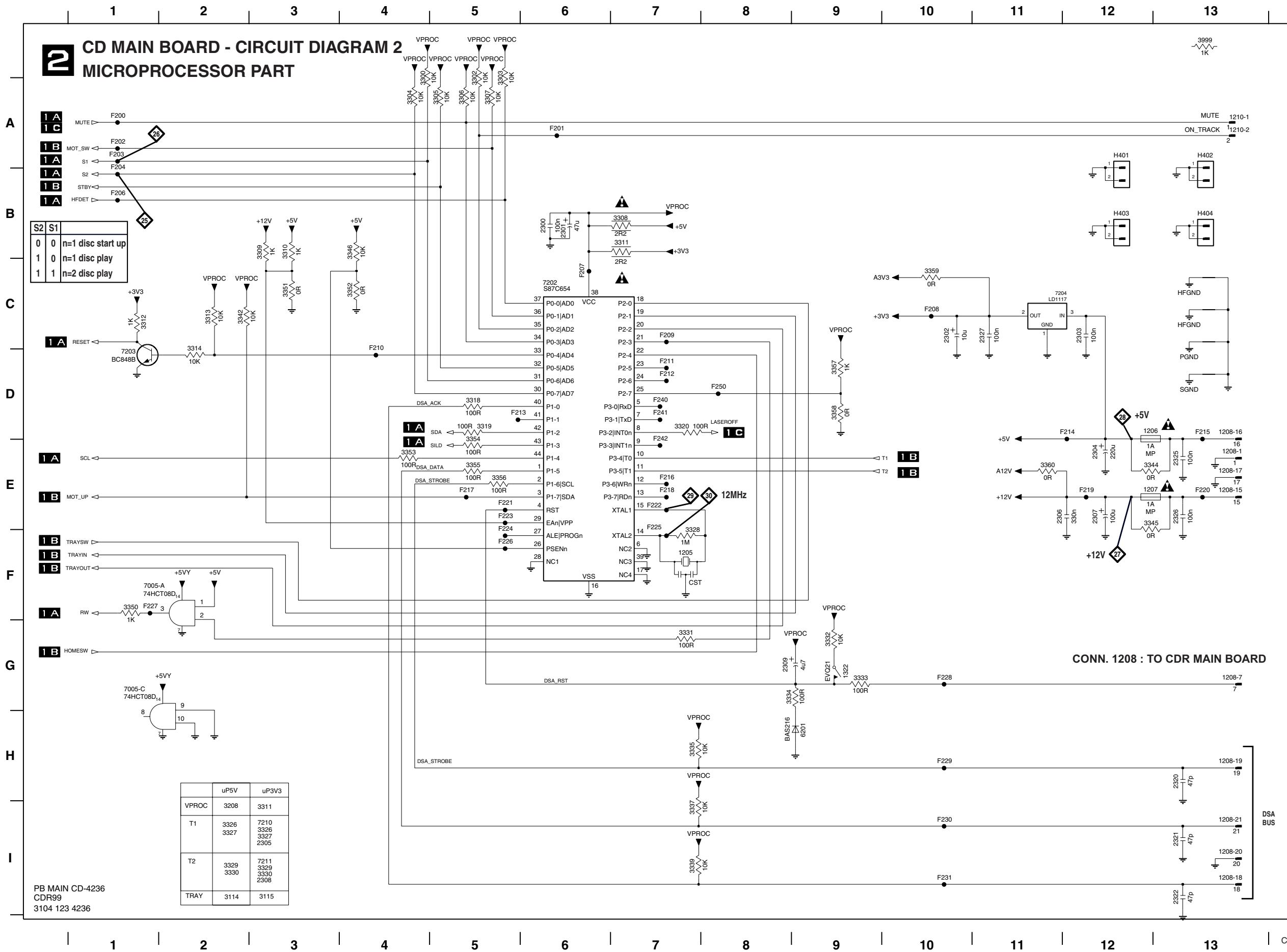

- 1205 F7
- 1206 D12
- 1207 E12
- 1208-1 E13
- 1208-15 D13
- 1208-16 D13
- 1208-17 E13
- 1208-18 H13
- 1208-19 H13
- 1208-20 H13
- 1208-21 H13
- 1208-7 G13
- 1210-1 A13
- 1210-2 A13
- 1322 G9
- 2300 B6
- 2301 B6
- 2302 C10
- 2303 C12
- 2304 E12
- 2306 E11
- 2307 E12
- 2309 G8
- 2320 H13
- 2321 H13
- 2322 H13
- 2325 E13
- 2326 E13
- 2327 C11
- 3300 A4
- 3302 A5
- 3303 A5
- 3304 A4
- 3305 A5
- 3306 A5
- 3307 A5
- 3308 B7
- 3309 B3
- 3310 B3
- 3311 B7
- 3312 C1
- 3313 C2
- 3314 D2
- 3318 D5
- 3319 D5
- 3320 D7
- 3328 F7
- 3331 G7
- 3332 G9
- 3333 G9
- 3334 G8
- 3335 H7
- 3337 I7
- 3339 I7
- 3342 C2
- 3344 E12
- 3345 E12
- 3346 B4
- 3350 F1
- 3351 C3
- 3352 C4
- 3353 E4
- 3354 E5
- 3355 E5
- 3356 E5
- 3357 D9
- 3358 D9
- 3359 C10
- 3360 E11
- 3999 A13
- 6201 H9
- 7005-A F1
- 7005-C G1
- 7202 C6
- 7203 D1
- 7204 C12
- H401 A12
- H402 A13
- H403 B12
- H404 B13

PB MAIN CD-4236
CDR99
3104 123 4236

Layout CD Main board (top view)

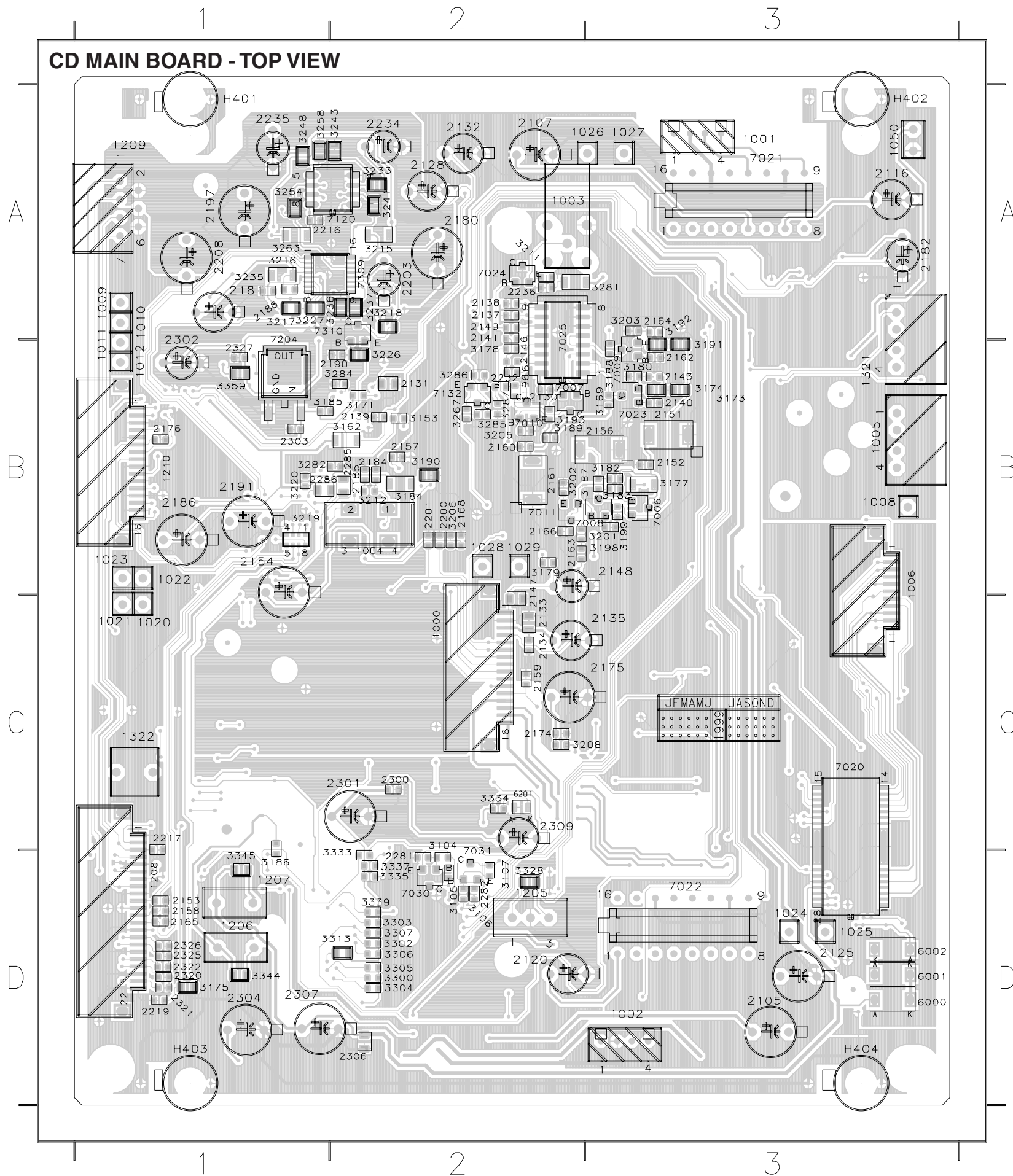

1000	A1
1001	A1
1002	A1
1003	A1
1004	A1
1005	A1
1006	A1
1007	A1
1008	A1
1009	A1
1010	A1
1011	A1
1012	A1
1013	A1
1014	A1
1015	A1
1016	A1
1017	A1
1018	A1
1019	A1
1020	A1
1021	A1
1022	A1
1023	A1
1024	A1
1025	A1
1026	A1
1027	A1
1028	A1
1029	A1
1030	A1
1031	A1
1032	A1
1033	A1
1034	A1
1035	A1
1036	A1
1037	A1
1038	A1
1039	A1
1040	A1
1041	A1
1042	A1
1043	A1
1044	A1
1045	A1
1046	A1
1047	A1
1048	A1
1049	A1
1050	A1
1051	A1
1052	A1
1053	A1
1054	A1
1055	A1
1056	A1
1057	A1
1058	A1
1059	A1
1060	A1
1061	A1
1062	A1
1063	A1
1064	A1
1065	A1
1066	A1
1067	A1
1068	A1
1069	A1
1070	A1
1071	A1
1072	A1
1073	A1
1074	A1
1075	A1
1076	A1
1077	A1
1078	A1
1079	A1
1080	A1
1081	A1
1082	A1
1083	A1
1084	A1
1085	A1
1086	A1
1087	A1
1088	A1
1089	A1
1090	A1
1091	A1
1092	A1
1093	A1
1094	A1
1095	A1
1096	A1
1097	A1
1098	A1
1099	A1
1100	A1

Layout CD Main board (bottom view)

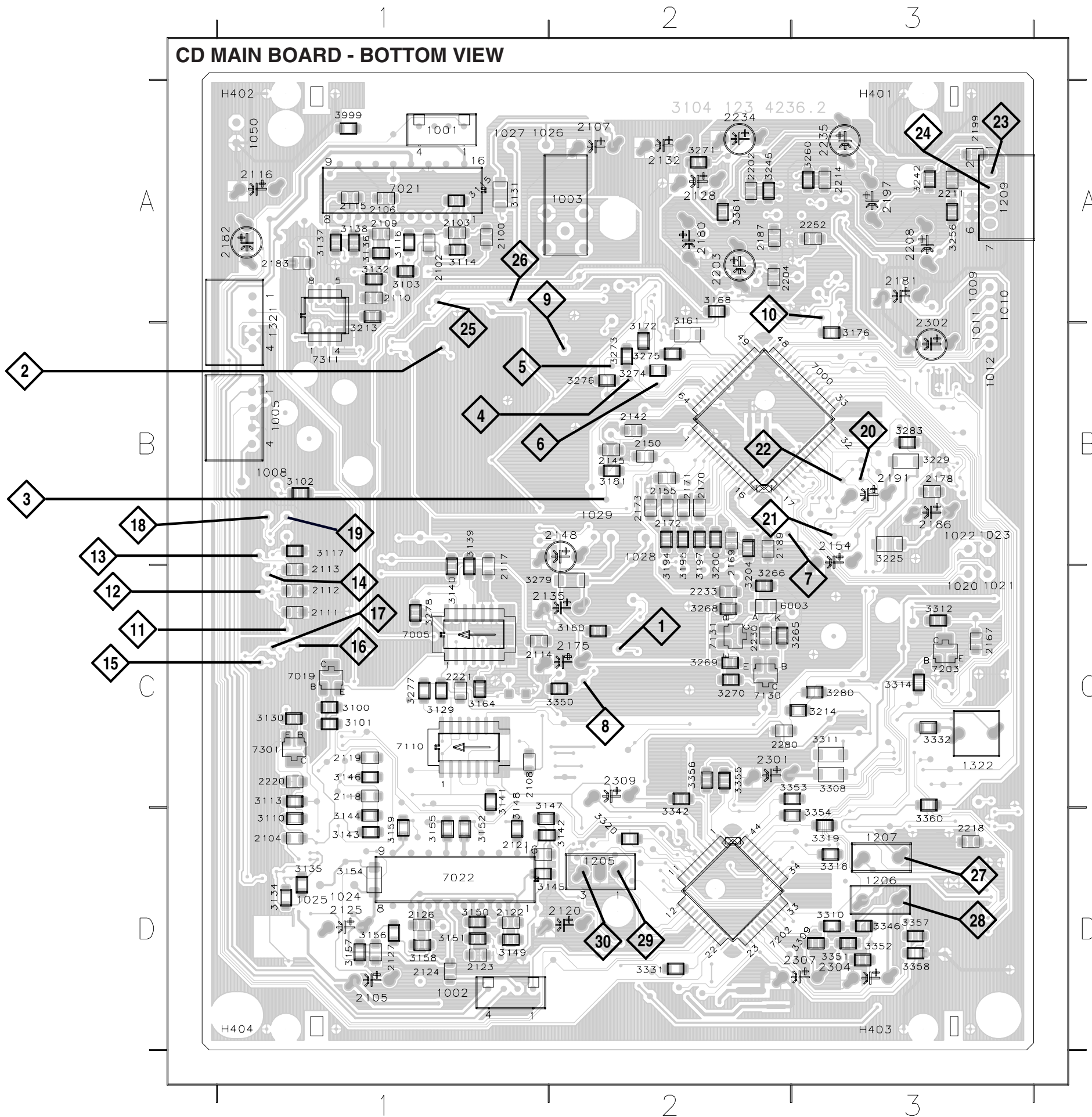

1	A1
2	A1
3	A1
4	A1
5	A1
6	A1
7	A1
8	A1
9	A1
10	A1
11	A1
12	A1
13	A1
14	A1
15	A1
16	A1
17	A1
18	A1
19	A1
20	A1
21	A1
22	A1
23	A1
24	A1
25	A1
26	A1
27	A1
28	A1
29	A1
30	A1
31	A1
32	A1
33	A1
34	A1
35	A1
36	A1
37	A1
38	A1
39	A1
40	A1
41	A1
42	A1
43	A1
44	A1
45	A1
46	A1
47	A1
48	A1
49	A1
50	A1
51	A1
52	A1
53	A1
54	A1
55	A1
56	A1
57	A1
58	A1
59	A1
60	A1
61	A1
62	A1
63	A1
64	A1
65	A1
66	A1
67	A1
68	A1
69	A1
70	A1
71	A1
72	A1
73	A1
74	A1
75	A1
76	A1
77	A1
78	A1
79	A1
80	A1
81	A1
82	A1
83	A1
84	A1
85	A1
86	A1
87	A1
88	A1
89	A1
90	A1
91	A1
92	A1
93	A1
94	A1
95	A1
96	A1
97	A1
98	A1
99	A1
100	A1
101	A1
102	A1
103	A1
104	A1
105	A1
106	A1
107	A1
108	A1
109	A1
110	A1
111	A1
112	A1
113	A1
114	A1
115	A1
116	A1
117	A1
118	A1
119	A1
120	A1
121	A1
122	A1
123	A1
124	A1
125	A1
126	A1
127	A1
128	A1
129	A1
130	A1
131	A1
132	A1
133	A1
134	A1
135	A1
136	A1
137	A1
138	A1
139	A1
140	A1
141	A1
142	A1
143	A1
144	A1
145	A1
146	A1
147	A1
148	A1
149	A1
150	A1
151	A1
152	A1
153	A1
154	A1
155	A1
156	A1
157	A1
158	A1
159	A1
160	A1
161	A1
162	A1
163	A1
164	A1
165	A1
166	A1
167	A1
168	A1
169	A1
170	A1
171	A1
172	A1
173	A1
174	A1
175	A1
176	A1
177	A1
178	A1
179	A1
180	A1
181	A1
182	A1
183	A1
184	A1
185	A1
186	A1
187	A1
188	A1
189	A1
190	A1
191	A1
192	A1
193	A1
194	A1
195	A1
196	A1
197	A1
198	A1
199	A1
200	A1
201	A1
202	A1
203	A1
204	A1
205	A1
206	A1
207	A1
208	A1
209	A1
210	A1
211	A1
212	A1
213	A1
214	A1
215	A1
216	A1
217	A1
218	A1
219	A1
220	A1
221	A1
222	A1
223	A1
224	A1
225	A1
226	A1
227	A1
228	A1
229	A1
230	A1
231	A1
232	A1
233	A1
234	A1
235	A1
236	A1
237	A1
238	A1
239	A1
240	A1
241	A1
242	A1
243	A1
244	A1
245	A1
246	A1
247	A1
248	A1
249	A1
250	A1
251	A1
252	A1
253	A1
254	A1
255	A1
256	A1
257	A1
258	A1
259	A1
260	A1
261	A1
262	A1
263	A1
264	A1
265	A1
266	A1
267	A1
268	A1
269	A1
270	A1
271	A1
272	A1
273	A1
274	A1
275	A1
276	A1
277	A1
278	A1
279	A1
280	A1
281	A1
282	A1
283	A1
284	A1
285	A1
286	A1
287	A1
288	A1
289	A1
290	A1
291	A1
292	A1
293	A1
294	A1
295	A1
296	A1
297	A1
298	A1
299	A1
300	A1
301	A1
302	A1
303	A1
304	A1
305	A1
306	A1
307	A1
308	A1
309	A1
310	A1
311	A1
312	A1
313	A1
314	A1
315	A1
316	A1
317	A1
318	A1
319	A1
320	A1
321	A1
322	A1
323	A1
324	A1
325	A1
326	A1
327	A1
328	A1
329	A1
330	A1
331	A1
332	A1
333	A1
334	A1
335	A1
336	A1
337	A1
338	A1
339	A1
340	A1
341	A1
342	A1
343	A1
344	A1
345	A1
346	A1
347	A1
348	A1
349	A1
350	A1
351	A1
352	A1
353	A1
354	A1
355	A1
356	A1
357	A1
358	A1
359	A1
360	A1
361	A1
362	A1
363	A1
364	A1
365	A1
366	A1
367	A1
368	A1
369	A1
370	A1
371	A1
372	A1
373	A1
374	A1
375	A1
376	A1
377	A1
378	A1
379	A1
380	A1
381	A1
382	A1
383	A1
384	A1
385	A1
386	A1
387	A1
388	A1
389	A1
390	A1
391	A1
392	A1
393	A1
394	A1
395	A1
396	A1
397	A1
398	A1
399	A1
400	A1
401	A1
402	A1
403	A1
404	A1
405	A1
406	A1
407	A1
408	A1
409	A1
410	A1
411	A1
412	A1
413	A1
414	A1
415	A1
416	A1
417	A1
418	A1
419	A1
420	A1
421	A1
422	A1
423	A1
424	A1
425	A1
426	A1
427	A1
428	A1
429	A1
430	A1
431	A1
432	A1
433	A1
434	A1
435	A1
436	A1
437	A1
438	A1
439	A1
440	A1
441	A1
442	A1
443	A1
444	A1
445	A1
446	A1
447	A1
448	A1
449	A1
450	A1
451	A1
452	A1
453	A1
454	A1
455	A1
456	A1
457	A1
458	A1
459	A1
460	A1
461	A1
462	A1
463	A1
464	A1
465	A1
466	A1
467	A1
468	A1
469	A1
470	A1
471	A1
472	A1
473	A1
474	A1
475	A1
476	A1
477	A1
478	A1
479	A1
480	A1
481	A1
482	A1
483	A1
484	A1
485	A1
486	A1
487	A1
488	A1
489	A1
490	A1
491	A1
492	A1
493	A1
494	A1
495	A1
496	A1
497	A1
498	A1
499	A1
500	A1

6. Diagnostic Software

6.1 Dealer mode

The purpose of the dealer mode is to prevent people taking out the CD inside the player at exhibitions, showrooms etc.. This mode disables the open/close function of the player. The dealer mode can be switched on and off pressing keys [OPEN/CLOSE] and [STOP] of the CDR player simultaneously while switching on the unit. The dealer mode is stored in the flash memory and can only be changed by executing the above actions.

6.2 Dealer diagnostics

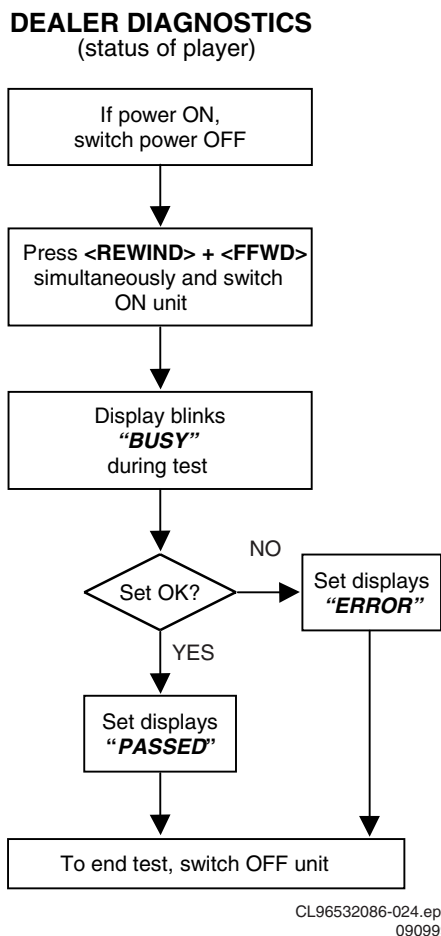

Figure 6-1

6.2.1 Description

The intention of the dealer diagnostics is to give an indication of the CDR player status. An inexperienced, even non-technical dealer will/can perform the test. Tests are executed automatically without need for external tools or disassembly of the unit. This test checks the CDR main board using the same tests as the electrical service diagnostics program. Only the result of the test, "PASSED" or "ERROR", will be shown on the display. Pressing keys [F FWD] and [REWIND] simultaneously while switching on the unit, starts the test. Switching off the unit ends the test.

6.2.2 Requirements to perform the test

- Working keyboard to start up the test.
- Working local display to check the output messages.

6.3 Electrical service diagnostics

ELECTRICAL SERVICE DIAGNOSTICS

(software versions, test for defective components)

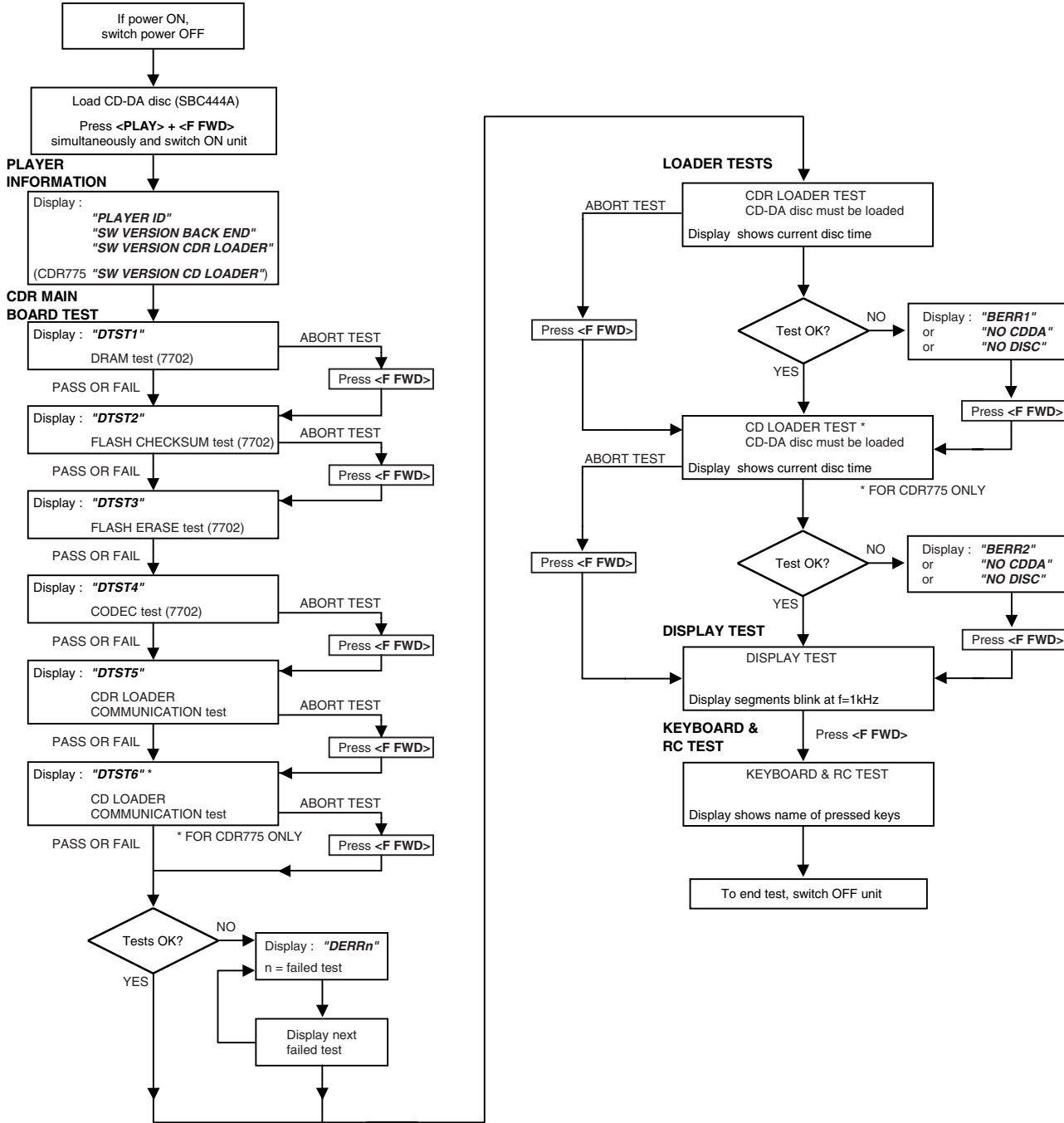

Figure 6-2

6.3.1 Description

The intention of the electrical service diagnostics is to show the software versions present in the player and to direct the dealer towards defective internal units. The units are : the CDR main board, the CDR loader, the CD loader in case of a CDR779 and the keyboard/display board. A sequence of tests is executed automatically. Some of the tests can be aborted or skipped without the result being taken into account. External tools or disassembly of the unit is not necessary to get the diagnostic information. Pressing keys [PLAY/PAUSE] and [F FWD] simultaneously while switching on the unit, starts the test. Switching off the unit ends the test.

6.3.2 Requirements to perform the test

- Working keyboard to start up the test.
- Working local display to check the output messages.
- A CD-DA disc with a minimum of 3 tracks in all trays to perform the disc test.

6.3.3 Description of the tests

Player information

In this part of the test the following important information can be checked without removing the cover :

- Recorder ID.
- SW-version back end of player.
- SW-version CDR loader.
- SW-version CD loader (only for CDR779).

CDR main board test

[F FWD] key. The message "DERRn" will be displayed with n indicating the faulty test number.

If one of the tests is aborted with the [F FWD] key, no error message will be displayed for this test. The flash data erase test ("DTST3") can not be aborted !

The CDR main board test consists out of :

DRAM test

Display : "DTST1". The DRAM used for buffer management is tested by writing, reading and verifying test patterns.

Flash checksum test

Display : "DTST2". This test checks the checksum of the player's SW stored in the flash.

Flash data erase

Display : "DTST3". During this test, all temporary information (CDtxt) in the flash is erased.

CODEC (ADC/DAC) test

Display : "DTST4". This test checks the CODEC IC by writing, reading and verifying test patterns. The test is not applicable for CDR779.

CDR communication test

Display : "DTST5". The communication between the host processor (DASP) and the CDR loader via the DSA-R-bus is tested.

CD communication test

Display : "DTST6"). The communication between the host processor (DASP) and the CD loader is tested. The test is only applicable for CDR779.

Loader tests

These tests determine if the CDR loader and the CD loader in case of a CDR779 work correctly. A CD-DA disc with a minimum of 3 tracks needs to be inserted in both loaders. A disc test is executed to check focus control, disc motor control, radial control and jump grooves control. The disc test

is performed by audio play-back of 5 seconds at the beginning, middle and end of the disc.

CDR loader test

During the test, the current disc time is shown. In case of an error the message "BERR1" will be displayed and the [F FWD] key must be pressed to continue with the following test. Pressing the [F FWD] key also aborts this test.

CD loader test

For CDR779 only. During the test, the current disc time is shown. In case of an error the message "BERR2" will be displayed and the [F FWD] key must be pressed to continue with the following test. Pressing the [F FWD] key also aborts this test.

Display test

All segments will blink at a frequency of 1 Hz. Pressing the [F FWD] key will start the next test because the user has to check for himself if all segments work properly.

Keyboard and remote control tests

The test will give the user the ability to test every key without executing the function assigned to it. Therefore, the user needs to press every key on the keyboard and the remote control. The display will show the name of the key being pressed. Pressing more than one key at once will give an unpredictable result except for the service combinations : [PLAY/PAUSE] + [STOP], [PLAY/PAUSE] + [F FWD], [F FWD] + [REWIND], [ERASE] + [RECORD], [PLAY/PAUSE] + [RECORD], [OPEN/CLOSE] + [PROGRAM].

6.4 Mechanical service diagnostics

MECHANICAL SERVICE DIAGNOSTICS

(test for defective components)

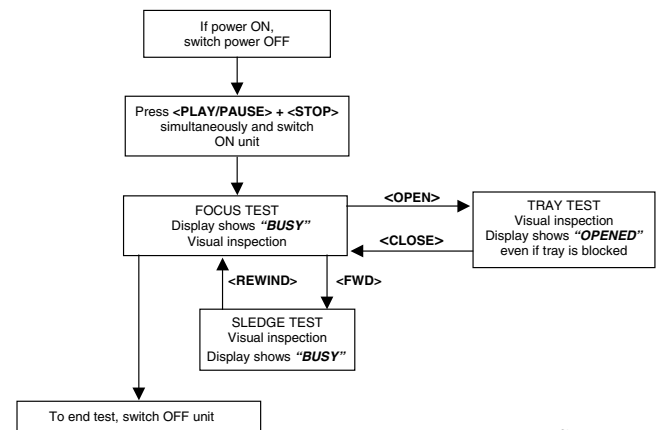

CL96532086_026.eps
080999

Figure 6-3

6.4.1 Description

No external tools are required to perform this test. The cover needs to be removed because the user has to check the movements of the tray, focus and sledge visually. Pressing keys [PLAY/PAUSE] and [STOP] simultaneously while switching on the unit, starts the test. Switching off the unit ends the test. In case of a CDR779, one can check the CD loader mechanics in the same way by pressing the above key combination on the CD player keys.

6.4.2 Requirements to perform the test

- Working keyboard to cycle through the tests and to start up the test.
- Working local display to check the output messages.

6.4.3 Description of the tests

Focus control test

The focussing lens is continuously moving up and down. The display reads "BUSY".

Sledge control test

After pressing [F FWD] the sledge continuously moves up and down. Pressing [REWIND] stops the sledge at the position it is in and the focus control test resumes. The display reads "BUSY".

Tray control test

This test starts from within the focus control test routine. Pressing [OPEN/CLOSE] moves the tray in or out. In the tray open position one can initiate focus and sledge tests by pressing [F FWD]. One has to stop these tests pressing [REWIND] before it is possible to close the tray again. Depending on the action the display reads "OPEN", "OPENED", "CLOSE" or "BUSY".

6.5 DC-erase service mode

DC ERASE SERVICE MODE (erasure of complete CD-RW)

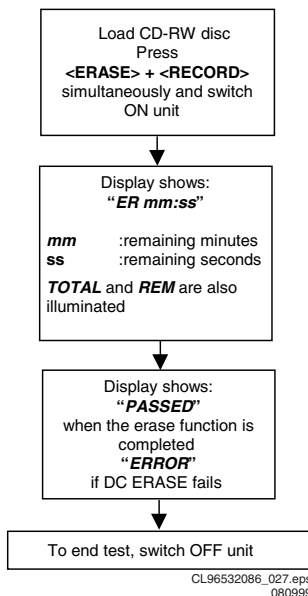

Figure 6-4

6.5.1 Description

This test is initiated by pressing [ERASE] and [RECORD] simultaneously while switching on the unit. The player will erase a complete CD-RW disc (including PMA and ATIP lead out area) at speed N=2. The display shows the countdown of the remaining time required for the operation to complete. The format is "ER mm:ss", where "mm" are the remaining minutes and "ss" the remaining seconds. After completion the message "PASSED" is shown, and the player has to be switched off and on again to start up in normal operating mode. Switching off the unit before completion of the test, leaves the disc in an unpredictable state. In such case only a complete DC-erase procedure can recover the CD-RW disc.

6.5.2 Requirements to perform the test

- Functional CDR player.
- A CD-RW audio disc must be present in the tray.

6.6 Burn in mode

6.6.1 Description:

The Burn In mode is an endless cycle of:

- DC-Erase to erase the CDRW disc with maximum laser power.
- Recording a CDRW disc
- Finalising at double speed

The Burn In mode is used to test intermittent faults of the loader.

6.6.2 Requirements to perform the test:

- Working Local Keyboard: needed to start up the test.
- Working Local Display: all output messages must be displayed on the local display.
- Analog source connected to the CDR99 player
- CDRW disc in tray

Burn in sequence

– Initialisation

The 'Burn In' mode is initiated by pressing the [PLAY/PAUSE] and [RECORD] key on the local keyboard at the same time, and then switching the POWER switch on.

– Continuous loop

The following picture shows the burn in sequence.

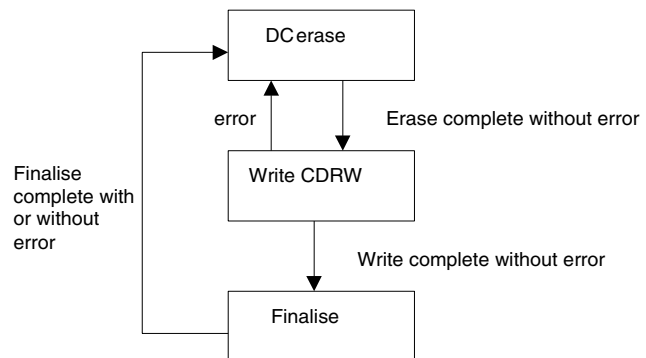

Figure 6-5 Burn in sequence

Continuously do DC erase, record complete CDRW and then finalise until the player is powered off.

When an error is detected during writing, the DC erase procedure is called again., the disc will be DC erased and the cycle starts again.

During the test the display shows the number of hours for which the test is running and the number of errors detected during the test. The display looks as follows : "HH BI RE FE"

HH	:	number of hours on digits 1 and 2
"BI"	:	burn in mode, digits 3 and 4
RE	:	number of errors detected during DC erase and write CDRW modes on digits 7 and 8
FE	:	number of errors detected during finalise modes on digits 10 and 11

If started up with a disc other than

a CDRW disc the display shows	:	"WRONG DISC",
if no disc is inserted display	:	"NO DISC".

– End of test

To exit the Burn In mode, power off the player.

7. Faultfinding trees

7.1 CDR-Module

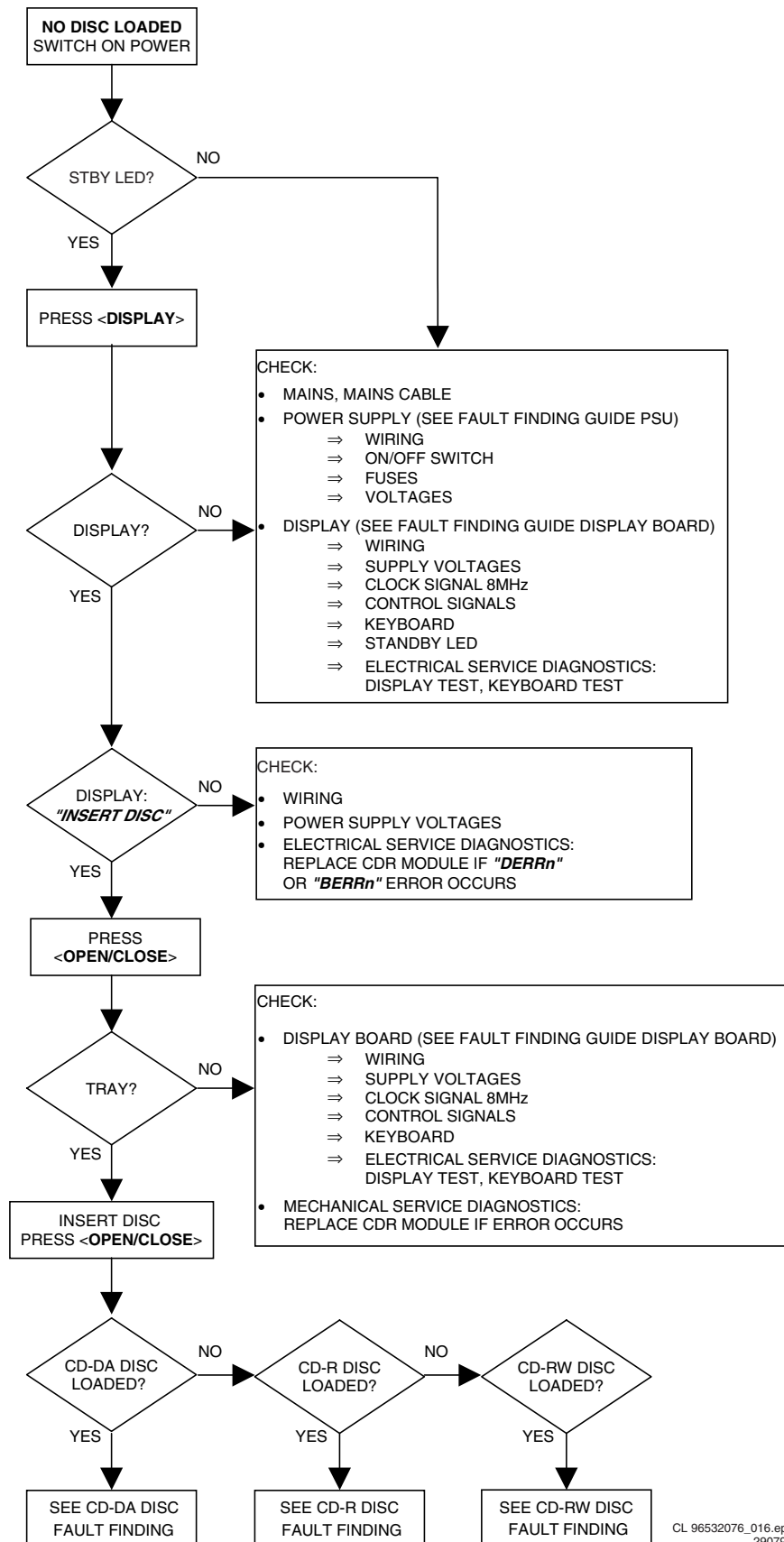

CL 96532076_016.eps
290799

Figure 7-1

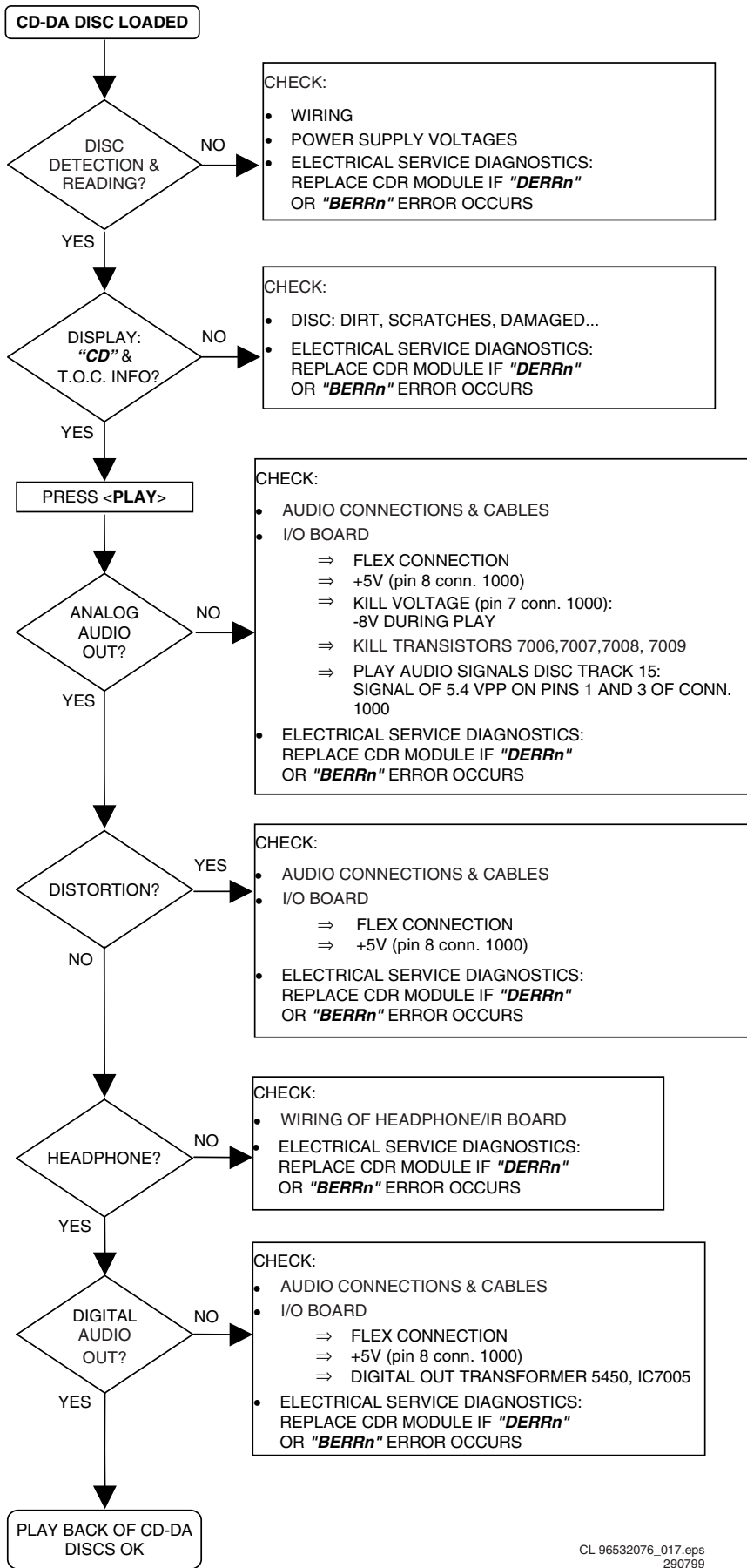

CL 96532076_017.eps
290799

Figure 7-2

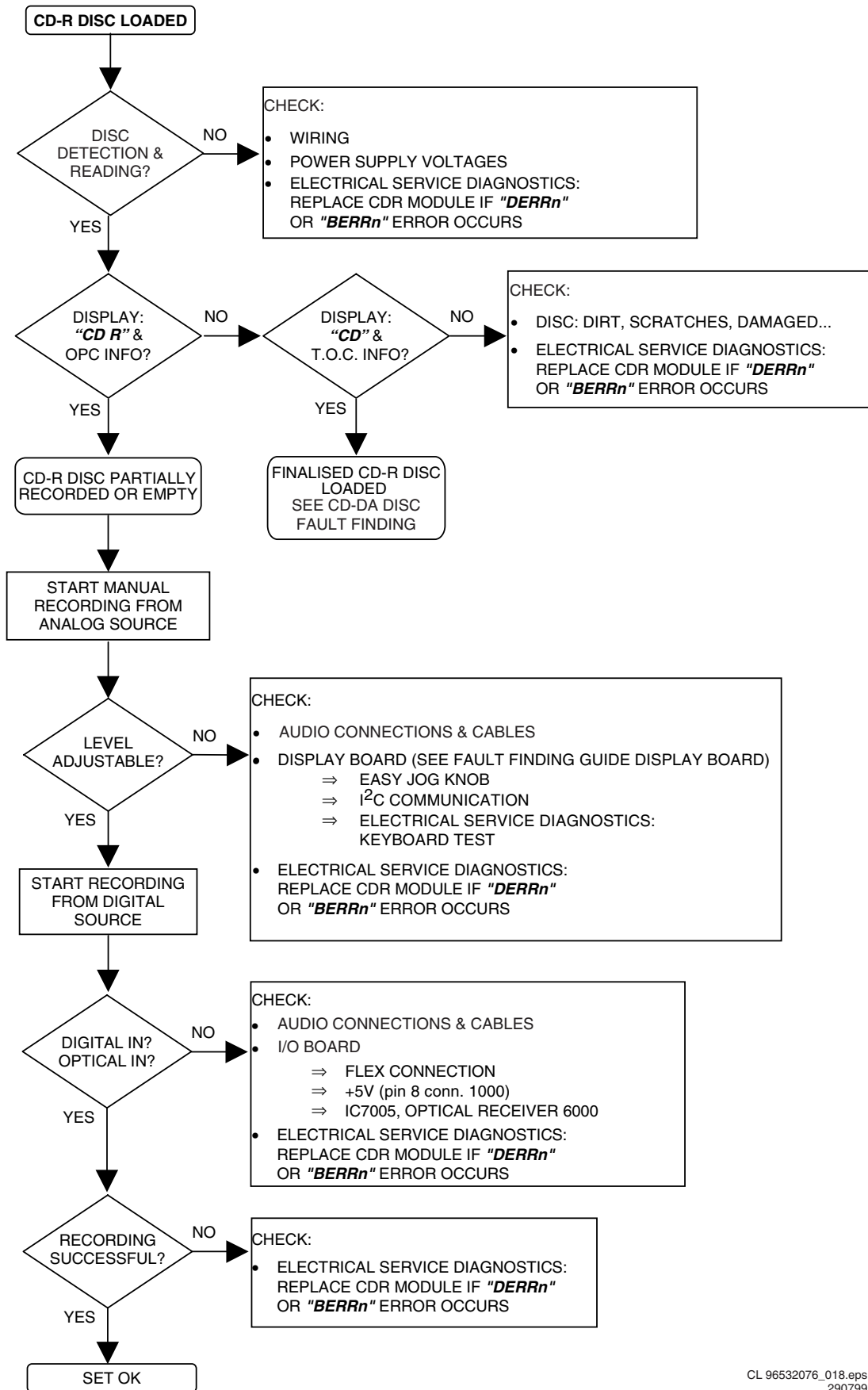

Figure 7-3

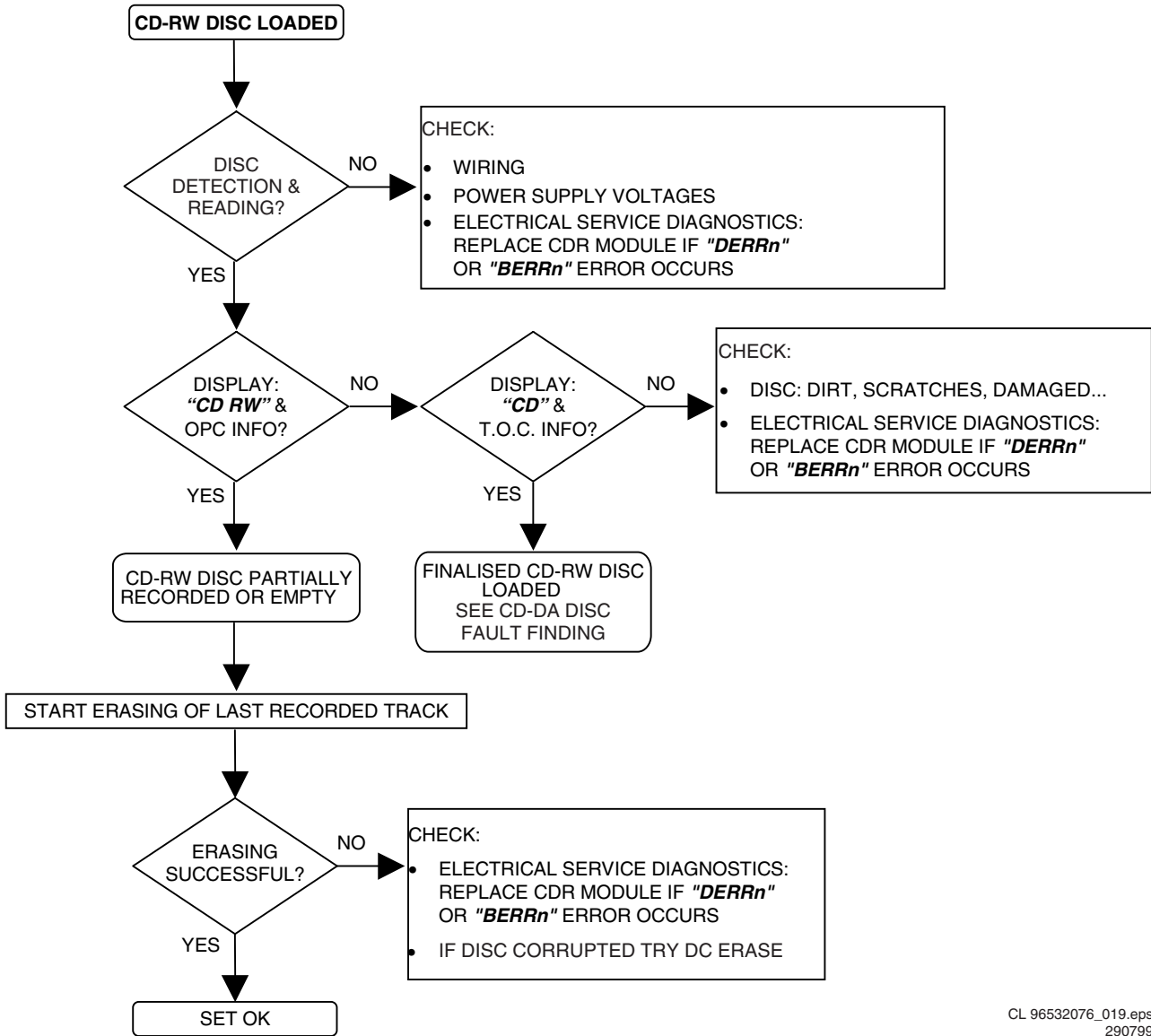

Figure 7-4

7.2 CD Module

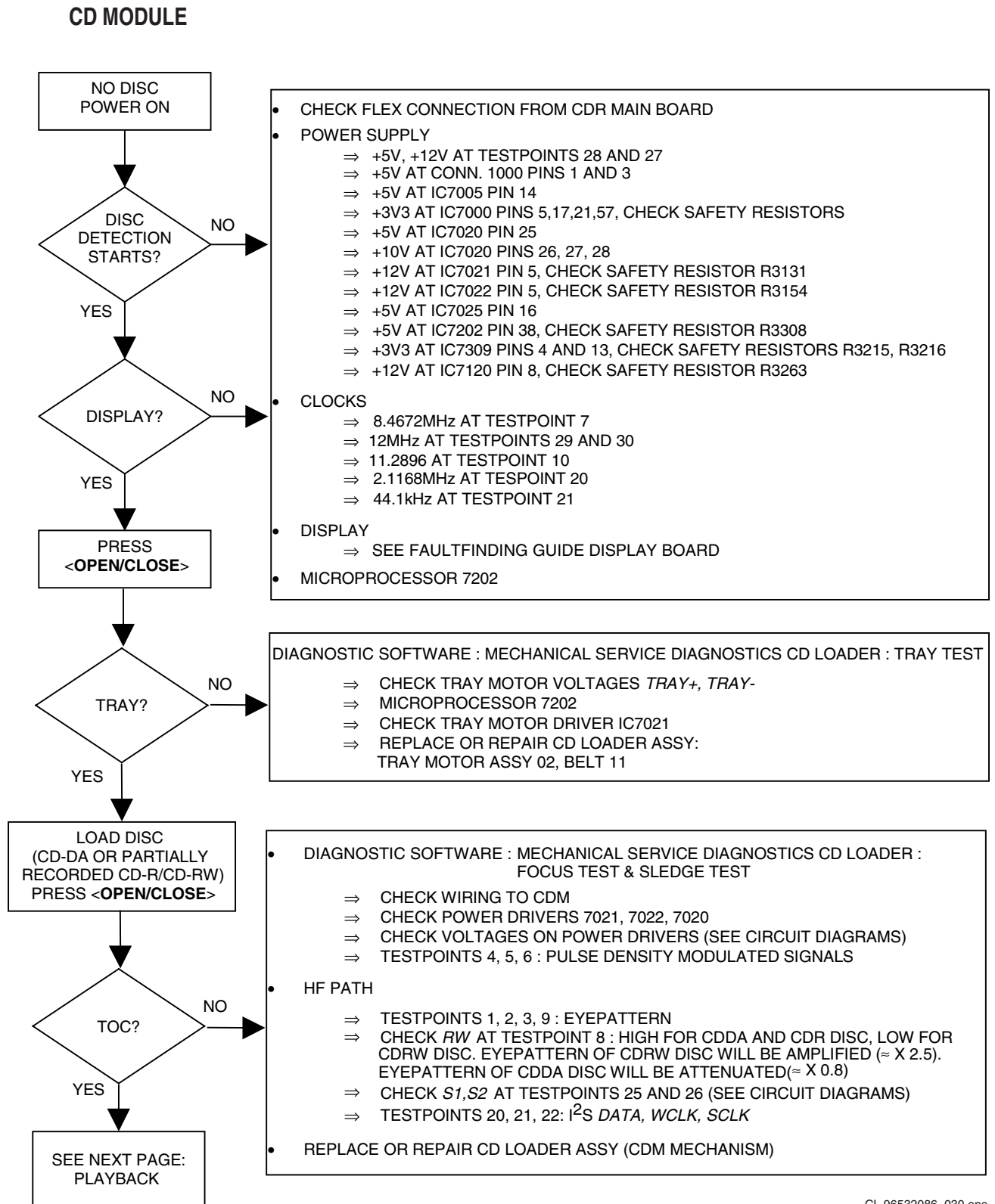
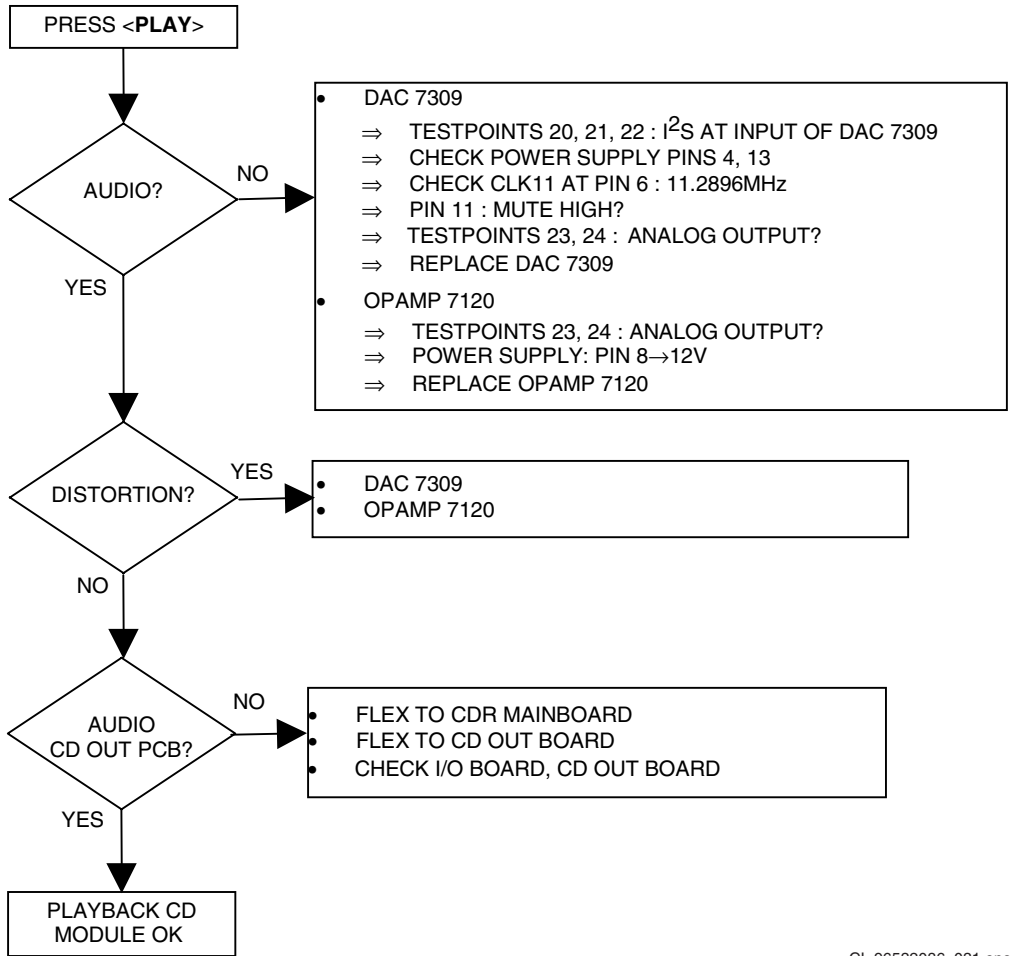

Figure 7-5

CD MODULE PLAYBACK



CL 96532086_031.eps
080999

Figure 7-6

8. Faultfinding Guide

8.1 Display Board

8.1.1 Description of display board

General description

The display board has three major parts : the FTD (Fluorescent Tube Display), the display controller TMP87C874F and the keyboard. The display controller is controlled by the DASP master processor on the CDR main board. The communication protocol used is I2C. So all the information between DASP and display controller goes via the SDA or I2C DATA and SCL or I2C CLK lines. Communication is always initiated by the DASP on the CDR main board. Unlike the previous generations of CDR players, the interrupt generated by the display controller at key-press or reception of remote control is not used. Instead, the DASP polls the display controller for these events.

Display controller TMP87C874F

TMP87C874F (IC7104) is a high speed and high performance 8-bit single chip microprocessor, containing 8-bit A/D conversion inputs and a VFT (Vacuum Fluorescent Tube) driver. In this application, its functions are :

- slave microprocessor.
- FTD driver.
- generates the square wave for the filament voltage required for an AC FTD.
- generates the grid and segment scanning for the FTD.
- generates the scanning grid for the key matrix.
- input for remote control.

All the communication runs via the serial bus interface I2C. The display controller uses an 8MHz resonator as clock driver.

BLOCK DIAGRAM

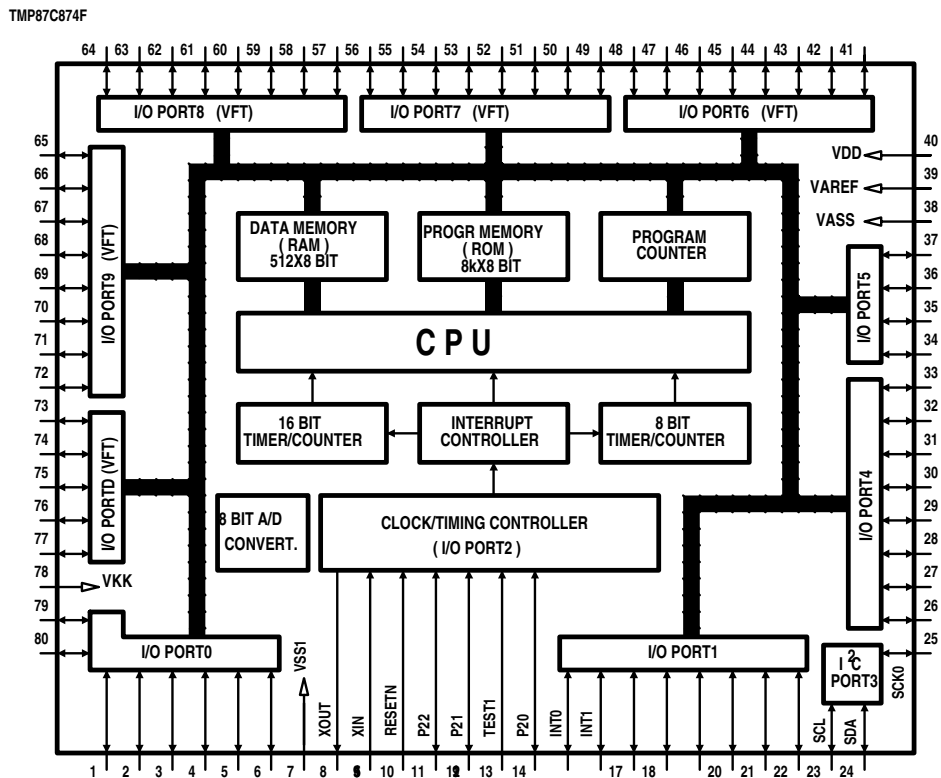

PIN DESCRIPTIONS

INT0	external interrupt input 0
INT1	external interrupt input 1
RESETN	reset signal input, active low
SCL	I2C-bus serial clock input/output
SDA	I2C-bus serial data input/output
TEST	test pin, tied to low
VAREF	analog reference voltage input
VASS	analog reference ground
VDD	+5V
VKK	VFT driver power supply
VSS	ground
XIN, XOUT	resonator connecting pins for high-frequency clock

CL 96532076_028.eps
290799

Figure 8-1

8.1.2 Test instructions

Supply voltages

The display board receives several voltages via connector 1119 (and connector 1121 for CDR570/930).

- VFTD : $-38V \pm 5\%$ measured at pin 2 of conn. 1119.
- VDC1-VDC2 : $3V8 \pm 10\%$ measured between pin 1 and 3 of conn. 1119.
- +5V : $+5V \pm 5\%$ measured at pin 10 of conn. 1119 (pin 4 of conn. 1121 for CDR770).

Voltages VFTD, VDC1 and VDC2 are produced in the power supply unit and sent to the display board via the CDR main board. The +5V voltage is produced on the CDR main board as D5V.

Clock signal

As clock driver for the display controller, a resonator of 8 MHz (1110) is used. The signal can be measured at pins 8 and 9 of the display controller : $8 \text{ MHz} \pm 5\%$.

Control signals

RESET

The reset signal comes via pin 4 of conn. 1119 from the DASP master processor on the CDR main board (SYS_RESET). The reset is low active. It should be kept low during power up for at least 3 machine cycles with supply voltage in operating range and a stable clock signal (1 machine cycle = $12 \times 1/Fc$ (8 MHz) sec.). During normal operation, the reset should be high (3V3). The high signal is 3V3 because the DASP operates on 3V3.

I2C DATA/I2C CLK

These lines connect to the DASP master processor via respectively pin 5 and pin 7 of conn. 1119 (pin 5 of conn. 1119 and pin 1 of conn. 1121 for CDR570/930). When there is no communication, they should have the high level (+5V). The oscillogram below gives an indication of how these signals should look like.

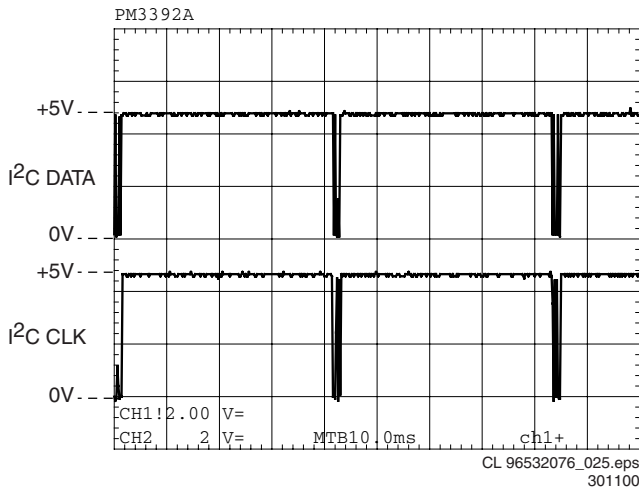

Figure 8-2 'I2C signals'

FTD drive lines

Filament voltage

Should measure $3.8V \pm 10\%$ (=VDC1-VDC2) between pins 1-2-3 and pins 45-46-47 (pins 1-2 and pins 48-49 for CDR770) of the FTD (1113).

Grid lines

Level and timing of all grid lines, G1-->G15, can be checked either at the FTD itself or at the display controller. Grid lines G13, G14 and G15 each have an extra current amplifier in

line : T7203 for G13, T7204 for G14 and T7100 for G15. A typical grid line signal shows in the oscillogram below.

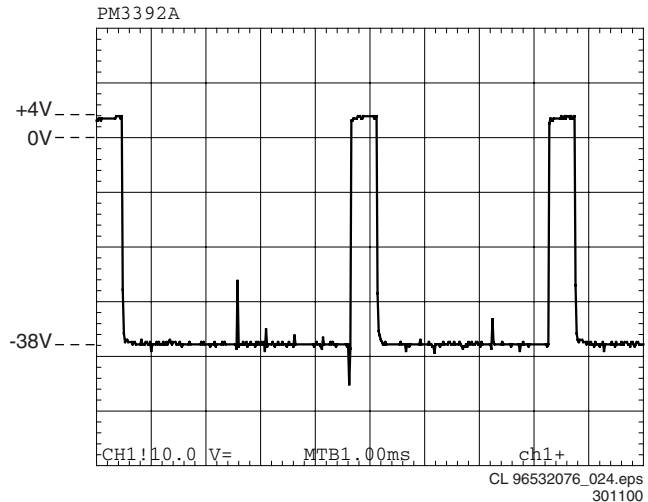

Figure 8-3 'Gridline'

Segment lines

Level and timing of all segment lines, P1-->P21 (P1-->P20 for CDR770), can be checked either at the FTD itself or at the display controller. The data on these segment lines however, depends on the characters displayed. The oscillogram below shows a segment line with data. A segment line without data maintains a -38V level.

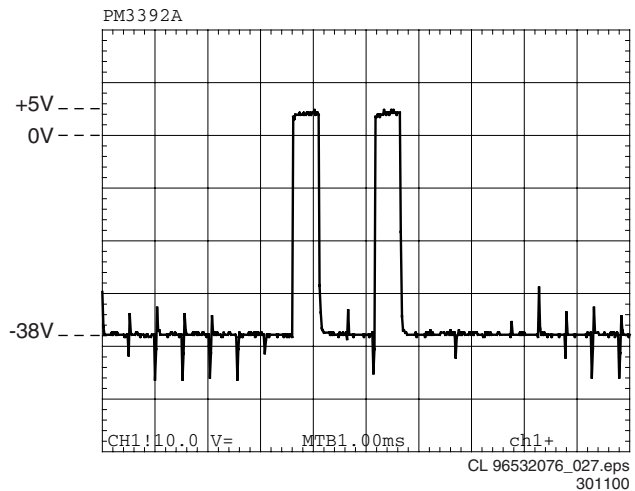

Figure 8-4 'Segment line'

Key matrix lines

The lines connected to pins 34, 35, 36 and 37 of the display controller act as matrix scanners. Without a key pressed, they maintain a low level. As soon as a key is pressed, the scanning line connected to that key puts out a scanning signal, which should look like the oscillogram below. This scanning signal goes via the pressed key to I/O port 4 of the display controller (pins 28 to 33). The display controller can now determine which key has been pressed. Without a key pressed, pins 28 to 33 of the display controller maintain a high level (+5V).

the direction of the rotation. Counting the pulses reveals the amount of rotation. Combining and decoding this information, the display controller will execute the appropriate task.

Push button operation

This button connects to the key matrix lines and thus the operation is identical to the ordinary keys. Without being pressed, pin 4 of the easy jog maintains the low level, pin 5 the high level. When pressed the scanning signal goes through the closed contact of pins 4 and 5, and can be checked at both pins.

IR receiver - remote control

In the CDR570/930 the IR receiver TSOP1736 (6101) is mounted on the display board. In the CDR770 that same IR receiver (6200) is mounted on a small board together with the headphone socket. In the CDR779 the IR receiver (6200) is mounted on its own small board. In all versions the IR receiver connects to the display controller. The signal coming from the receiver can be checked at pin 22 of the display controller. This signal is normally high (+5V). When the remote control is being operated, pulses mixed in with the +5V can be measured. The oscillogram gives an indication of how the signal looks like with the RC being operated.

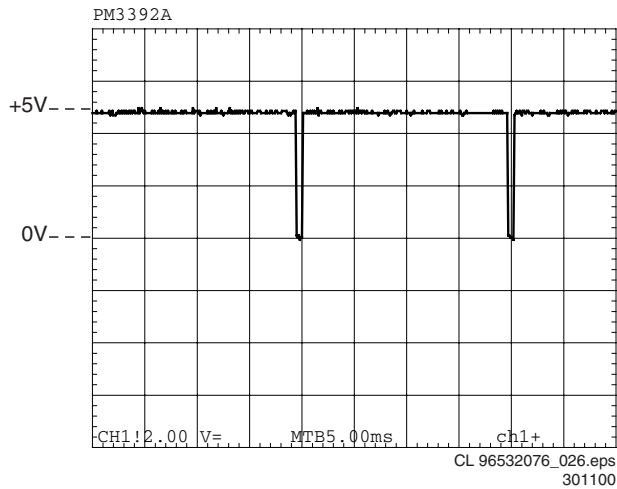

Figure 8-5 'Key matrix scan line'

Easy jog knob

Rotary operation

The easy jog knob (1050) incorporates a whole heap of user control possibilities in just one knob. Without the knob being operated, pin 1 and 3 of the knob (and thus pin 16 and 17 of the display controller), maintain the +5V level. Turning the knob clockwise briefly connects pin 1 to GND followed by pin 3.

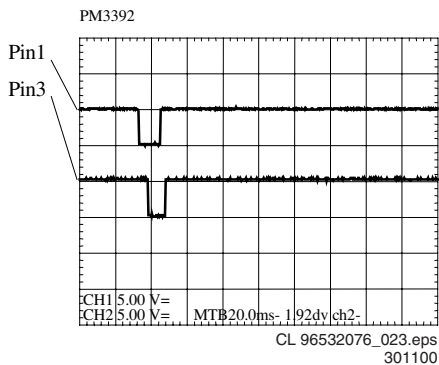

Figure 8-6 'Turn clockwise'

Turning the knob anti-clockwise briefly connects pin 3 to GND followed by pin 1.

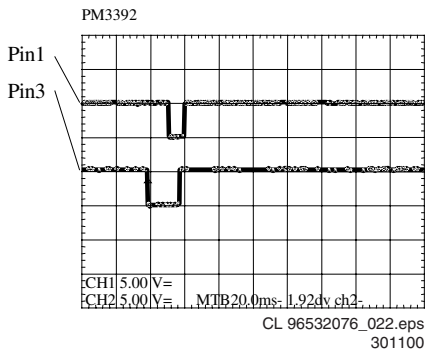

Figure 8-7 'Turn anti-clockwise'

The pulses created this way arrive at pin 16 and 17 of the display controller. The first pulse to arrive tells the controller

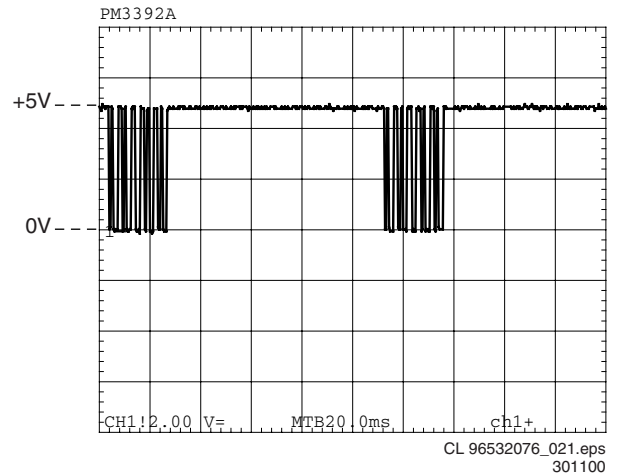

Figure 8-8 'IR receiver signal'

8.1.3 Display board troubleshooting guide

CL 96532076_020.eps
290799

Figure 8-9 'Display board troubleshooting'

8.2 Circuit description of the current mode power supply

8.2.1 Blockdiagram

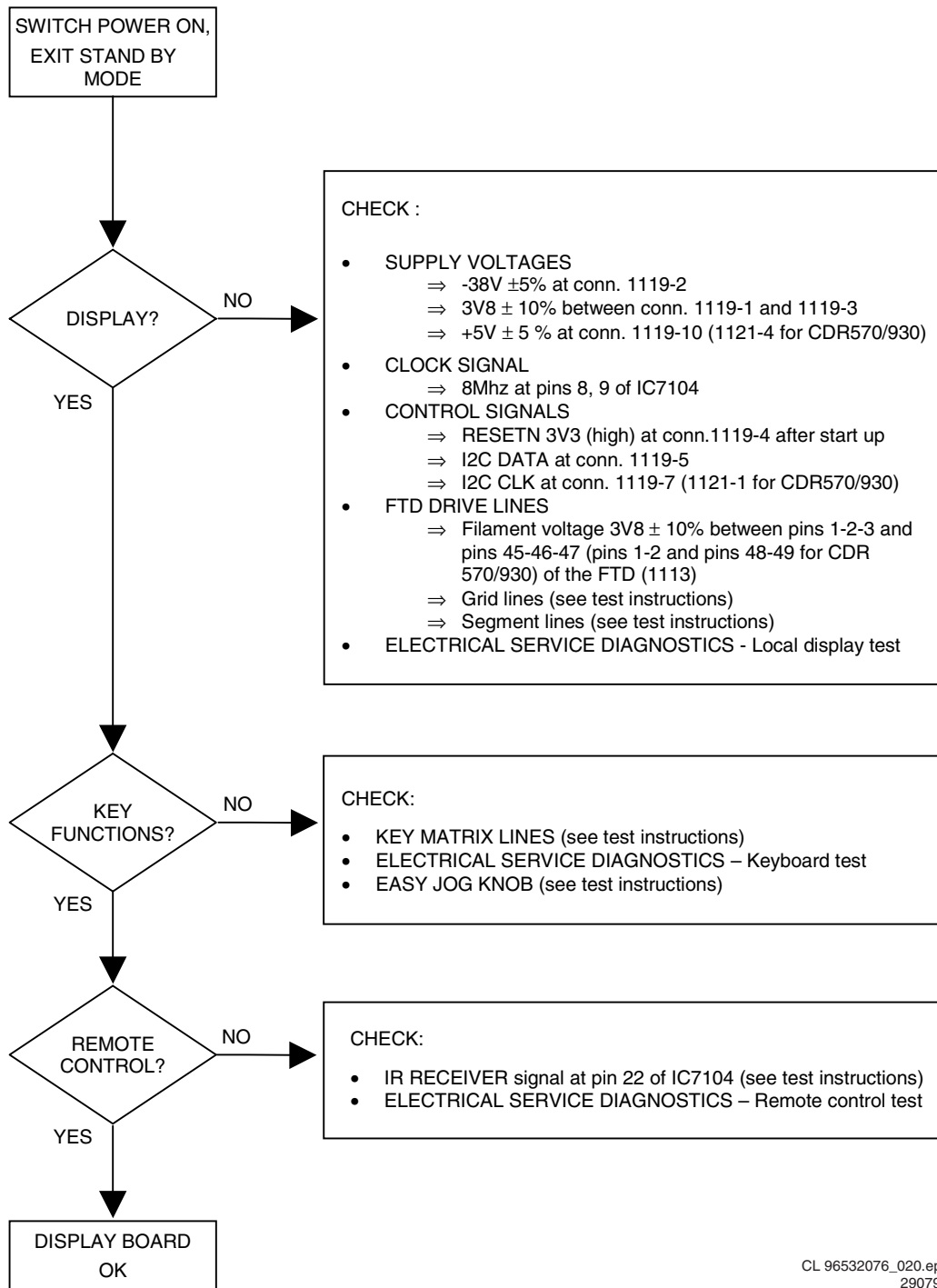
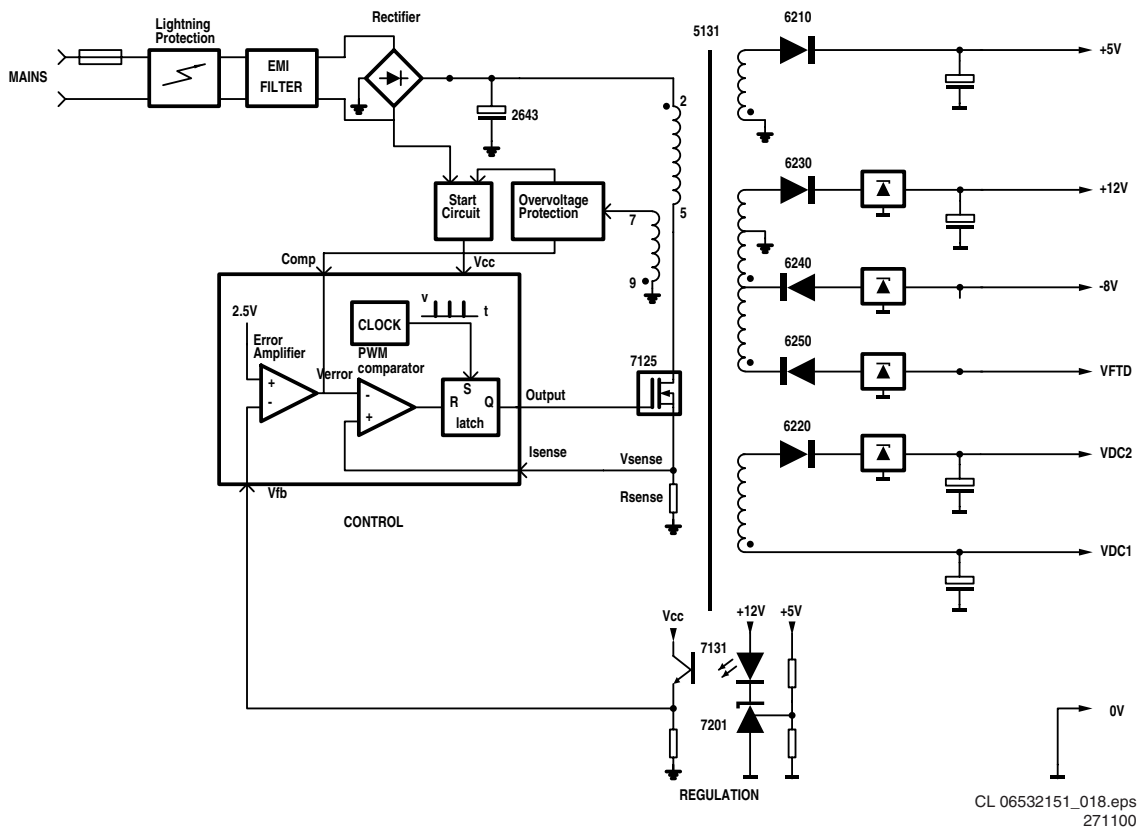

Figure 8-10

8.2.2 Function description

MOSFET 7125 is used as a power switch controlled by the controller IC 7110. When the switch is closed, energy is transferred from mains to the transformer. This energy is supplied to the load when the switch is opened. Through control of the switched-on time, the energy transferred in each cycle is regulated so that the output voltages are independent of load or input voltage variations. The controlling device UC3842 is an integrated pulse width modulator. A clock signal initiates power pulses at a fixed frequency. The termination of each output pulse occurs when a feedback signal of the inductor current reaches a threshold set by the error signal. In this way the error signal actually controls the peak inductor current on cycle-by cycle basis.

8.2.3 Description of UC3842

The input voltage Vcc(pin 7) is monitored by a comparator with hysteresis, enabling the circuit at 16V and disabling the circuit below 10V. The error amplifier compares a voltage Vfb(pin 2) related to the output voltage of the power supply, with an internal 2.5V reference. The current sense comparator compares the output of the error amplifier with the switch current Isense(pin 3) of the power supply. The output of the current sense comparator resets a latch, which is set every cycle by the oscillator. The output stage is a totem pole, capable of driving a MOSFET directly

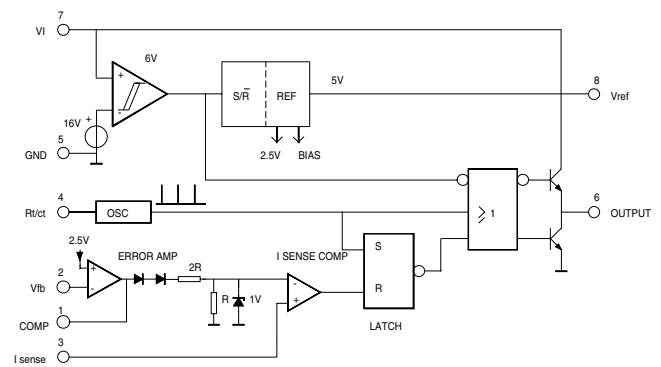

Figure B : Blockdiagram UC3842

CL 06532151_019.eps
271100

Figure 8-11

8.2.4 Start up sequence

- t1: Charging the capacitor at Vcc
C2129 will be charged via R3123 and R3134, C2133 and C2111 via R3129. The output is switched off during t1.
- t2: Charging of output capacitors
When the input voltage of the IC exceeds 14,5V, the circuit is enabled and starts to produce output pulses. The current consumption of the circuit increases to about 17mA, depending on the external loads of the IC. At first, the

capacitor at the Vcc pin will discharge because the primary auxiliary voltage, coming from winding 7-9 is below the Vcc voltage. At some moment during t2, the primary auxiliary voltages reaches the same level as Vcc.

This primary auxiliary voltage now determines the Vcc voltage

t3: regulation

The output voltage of the power supply is in regulation

t4: overload

When the output is shortened, the supply voltage of the circuit will decrease and after some time drop below the lower threshold voltage. At that moment, the output will be disabled and the process of charging the Vcc capacitor starts again. If the output is still shorted at the next t2 phase, the complete start-and stop sequence will repeat. The power supply comes in a hiccup mode.

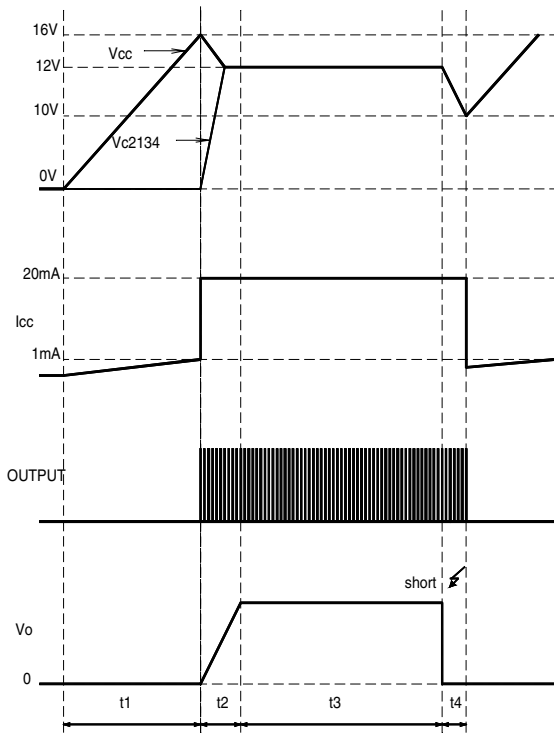

Figure C : Start-up sequence

CL 06532151_020.eps
271100

Figure 8-12

becomes reversed. This results in a current flow through the transformer's secondary winding via the diodes, electrolytic capacitors and the load. This current is also ramp shaped but decreasing.

TimeDEAD phase : when the stored energy has been supplied to the load, the voltage from the secondary windings falls below the output voltage (held constant by the electrolytic capacitors) plus the threshold voltage of the diodes. The current in the secondary winding stops flowing.

At this point, the drain voltage of the MOSFET is not yet zero because C2609 between drain and source contains a certain charge. This charge will start a sine-shaped ringing together with the transformer's self-induction.

The oscillator will start a next cycle which consists of the described three phases. The time of the different phases depends on the mains voltage and the load.

TimeDEAD is maximum at an input of 400VDC and minimum load, it will be zero at an input of 100VDC and overload.

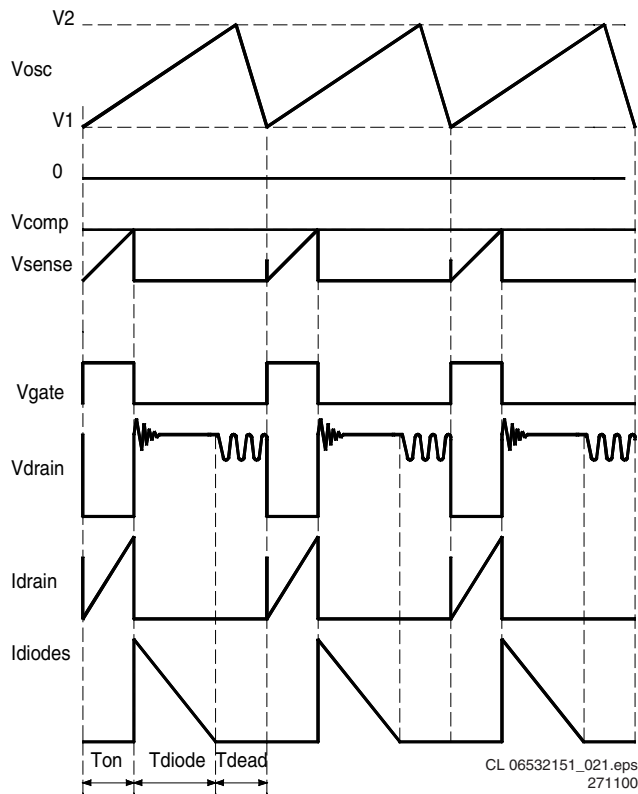

Figure 8-13

CL 06532151_021.eps
271100

8.2.5 Regulation

Figure 4 shows the most relevant signals during the regulation phase of the power supply.

The oscillator voltage ramps up and down between V1 and V2. The voltage at the current sense terminal is compared every cycle with the output of the error amplifier Vcomp. The output is switched off when the current sense level exceeds the level at the output of the error amplifier.

TimeON phase : A drain current will flow from the positive supply at pin 1 through the transformer's primary winding, the MOSFET and Rsense to ground. As the positive voltage at pin 1 of the transformer is constant, the current will increase linearly and create a ramp dependent on the mains voltage and the inductance of the primary winding. A certain amount of energy is stored in the transformer in the form of a magnetic field. The polarity of the voltages at the secondary windings is such that the diodes are non-conducting.

TimeDIODE phase : When the MOSFET is switched off, energy is no longer supplied to the transformer. The inductance of the transformer now tries to maintain the current which has been flowing through it at a constant level. The polarity of the voltage from the transformer therefore

8.2.6 Oscilloscopes

Oscilloscopes

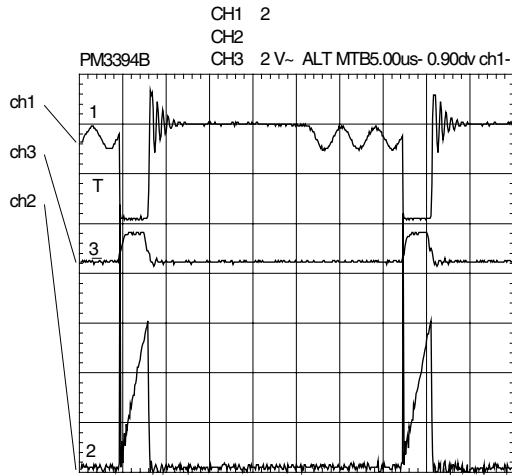

ch1 : Drain voltage
ch2 : Drain current
ch3 : Gate voltage

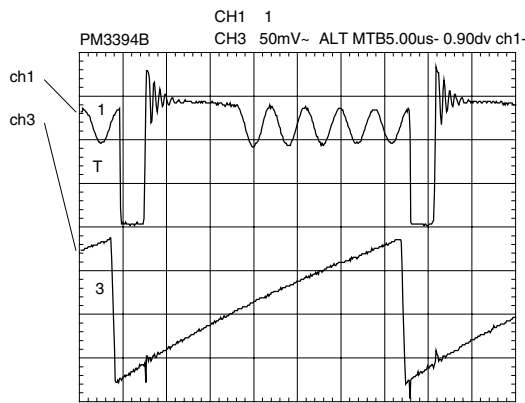

ch1 : Drain voltage
ch2 : Oscillator voltage

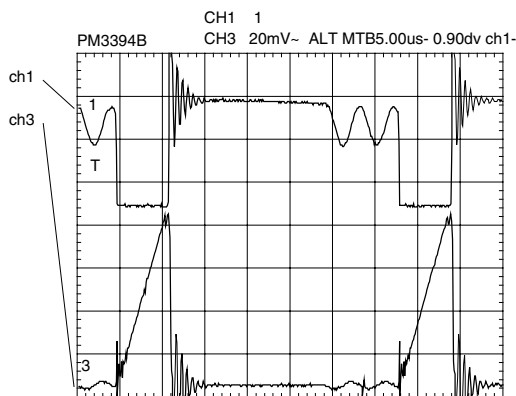

ch1 : Drain voltage
ch3 : Sense voltage

CL 06532151_022.eps
301100

Figure 8-14

8.2.7 Circuit description

Input circuit

The input circuit consists of a lightning protection circuit and an EMI filter.
The lightning protection comprises R3120, gasarrestor 1125 and R3124.
The EMI filter is formed by C2120, L5120, C2125 and R3124. It prevents inflow of noise into/from the mains.

Primary rectifier/smoothing circuit

The AC input is rectified by rectifier bridge 6102 and smoothed into C2121. The voltage over C2121 is approximately 300V. It can vary from 100V to 390V.

Start circuit and Vcc supply

This circuit is formed by R3123, R3134, C2129, D6129, R3129, R3111, C2133 and C2111.
When the power plug is connected to the mains voltage, the stabilised voltage over D6129(24V) will charge C2133 via R3129. When the voltage reaches 14,5V across C2111, the control circuit of IC7110 is turned on and the regulation starts. During regulation, Vcc of IC7110 will be supplied by the rectified voltage from winding 7-9 via L5132, D6132 and C2133.

Control circuit

The control circuit exists of IC7110, C2102, C2104, C2107, C2109, C2110, R3102, R3103, R3104, R3107, R3108, R3109 and R3110. C2102 and R3110 define the frequency of the oscillator.

Power switch circuit

This circuit comprises MOSFET 7125, Rsense 3126, 3127 and 3128, R3125, C2127, L5125, R3112 and R3113. R3125 is a pull-down resistor to remove static charges from the gate of the MOSFET.

Regulation circuit

The regulation circuit comprises opto-coupler 7200 which isolates the error signal from the control IC on the primary side and a reference component 7201. The TL431(7201) can be represented by two components:

- a very stable and accurate reference diode
- a high gain amplifier

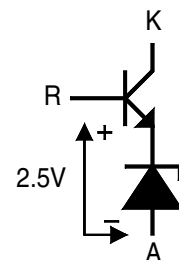

CL 06532151_023.eps
271100

Figure 8-15

TL431 will conduct from cathode to anode when the reference is higher than the internal reference voltage of about 2.5V. If the reference voltage is lower, the cathode current is almost zero.

The cathode current flows through the LED of the opto-coupler. The collector current of the opto-coupler flows through R3106, producing an error voltage, connected to voltage feedback pin 14 of IC7110.

Overvoltage protection circuit

This circuit consist of D6114, C2114, R3115and R3116.

When the regulation circuit is interrupted due to an error in the control loop, the regulated output voltage will increase (overvoltage). This overvoltage is sensed on the primary winding 7-9. When an overvoltage longer than $2.0\mu\text{s}$ is detected, the output is disabled until V_{cc} is removed and then re-applied. The power supply will come in a hiccup mode as long as the error in the control loop is present.

Secondary rectifier/smoothing circuit

There are 5 rectifier/smoothing circuits on the secondary side. Each voltage depends on the number of windings of the transformer.

The -8V supply is regulated by voltage regulator 7249.

On/off circuit

In off mode pin 1 and pin 2 of connector 0206 are connected. The high voltage (-8V, +12V) over opto coupler 7200 forces this one to conduct. IC 7110 is switched off

8.2.8 Troubleshooting PSU CDR3-ECO

Faultfinding diagram

TRUBLE SHOOTING POWER SUPPLY

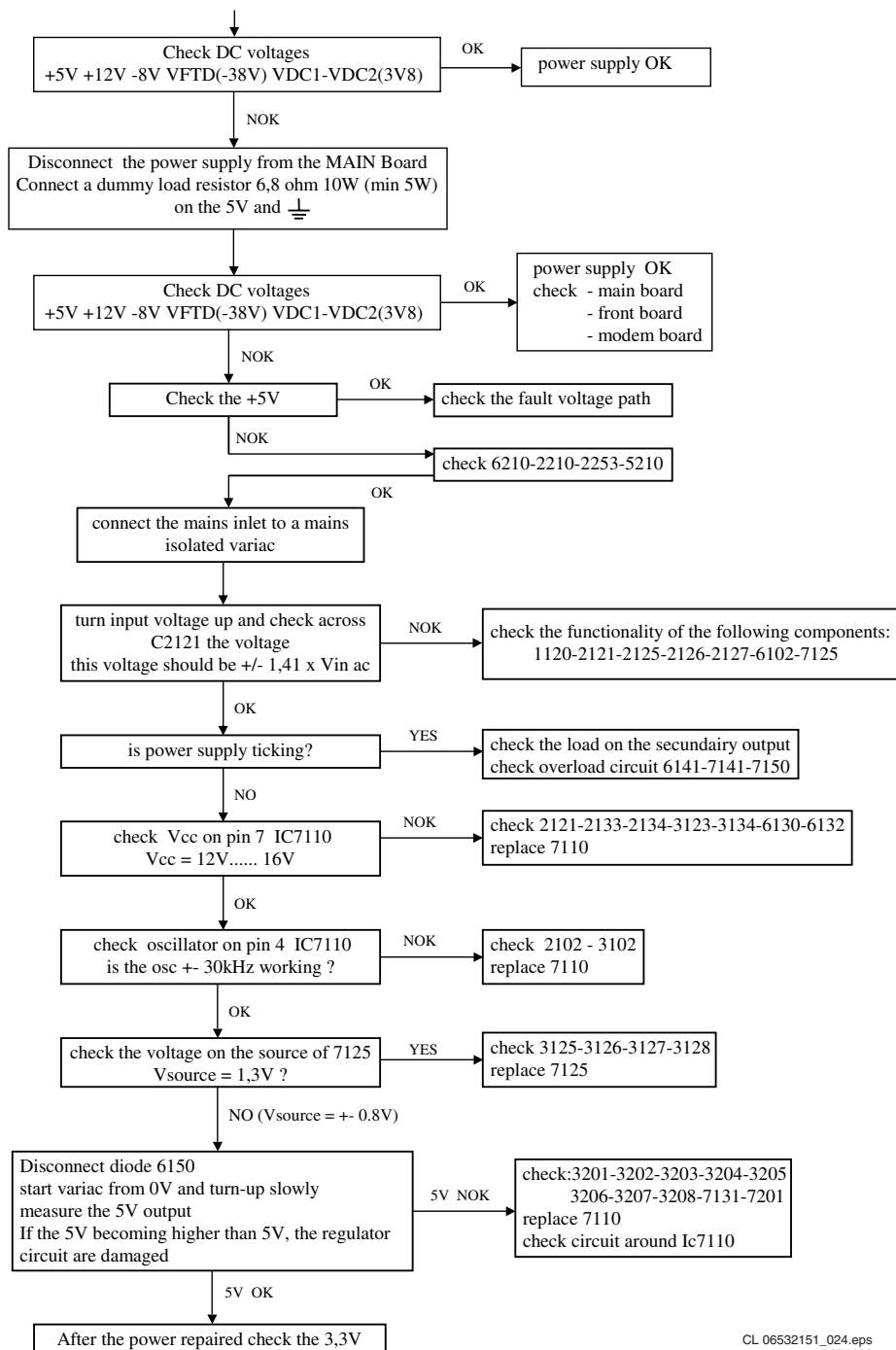

Figure 8-16

8.3 CD Main Board

The CD main board is built around the compact disc mechanism VAM1250 and a loader 1250. The CDM delivers diode signals and an unequalised high frequency signal. These signals are necessary inputs for the decoder CD10. Based on these signals the decoder will control the disc. The decoder is able to control the sledge, focus motor and turn table. When everything is "locked", the decoder delivers a digital output according to IEC958 standard, subcode to the microprocessor and I2S for reproducing analog audio signals by means of a D/A converter.

The microprocessor controls the CD10 and is slave of the master processor on the CDR main board in the CDR779. Both processors communicate via a DSA connection (data, strobe and acknowledge).

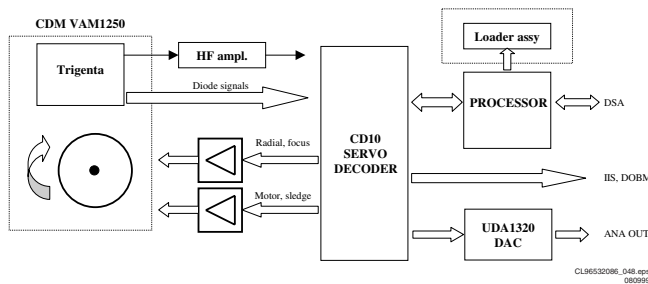

Figure 8-17

8.3.1 Supply Voltages

Description

The CD main board receives +5V and +12V from the CDR main board via respectively pin 16 and pin 15 of connector 1208. The +5V is split up into +5VHF and +5V. The +5VHF is used mainly for the diode currents and the HF-amplifier. The +5V is used for the digital part of the board. On the board a +3V3 is made from the +5V for the decoder CD10 and an A3V3 for the DAC UDA1320. The +12V is split up into A12V for the audio output stage and +12V for the power drivers of the CDM.

Measurements

Connect following supplies to next pins :

- +5V + 5% to pin 16 of connector 1208.
- +12V + 5% to pin 15 of connector 1208.
- Ground reference to pin 17 of connector 1208.

Keep microprocessor 7202 in reset by forcing pin 7 of connector 1208 to +5V. Check the following voltages :

Point	Voltage
Position 1000 pins 1,3	+5V ± 5%
Position 7000 pins 5,17,21,57	+3.3V ± 5%
Position 7005 pin 14	+5V ± 5%
Position 7020 pins 25	+5V ± 5%
Position 7020 pins 26,27,28	+10 ± 10%
Position 7021 pin 5	+12V ± 10
Position 7022 pin 5	+12V ± 10
Position 7025 pin 16	+5V ± 5%
Position 7202 pin 38	+5V ± 5% (other appl. 3V3 possible)
Position 7309 pins 4,13	+3V3 ± 5%
Position 7120 pin 8	+12V ± 10

CL96532086_049.eps
080999

Figure 8-18

8.3.2 Clock Signals

Description

The microprocessor has its own Xtal or resonator of 12MHz. The CD10 needs a clock of 8.4672MHz + 100ppm. This speed also relates to the disc speed. To avoid locking problems between the two drives in the CDR779, both drives run on the same clock. Therefore the CD main board gets the clock for the decoder from the CDR main board via pin 2 of connector 1208.

The DAC needs a system clock to drive its internal digital filters and to clock the I2S signals from the decoder. In our case this is 11.2896MHz (CL11) generated by the CD10.

Measurements

- Connect the power supply as described above in "1.1.1. Supply Voltages".
- Connect on pin 2 of position 1208 a clock signal of 8.4672 MHz (100ppm minimum rise time of 50ns and at TTL level (0V and +5V).
- Keep microprocessor 7202 in reset by forcing pin 7 at position 1208 to +5V.
- Release the reset. Now, the processor will reset the CD10 for at least 75µs.
- The output clock CL11 should be available now at pin 42 of the CD10.

Check the following frequencies :

Point	Frequency
Position 7000 pin 16	8.4672 MHz ± 100ppm
Position 7202 pins 14,15	12MHz ± 5%
Position 7309 pin 6	11.2896 MHz ± 100ppm
Position 7309 pin 1	2.1168 MHz ± 100ppm
Position 7309 pin2	44.1kHz ± 100ppm

CL96532086_050.eps
080999

Figure 8-19

8.3.3 CD10 Decoder/Servo SAA7324 (7000)

Description

The CD10 is a single chip combining the functions of a CD decoder, digital servo and bitstream DAC. The decoder/ servo part is based on the CD7. The decoding part supports a full audio specification and can operate at single speed (n=1) and double speed (n=2).

Block Diagram

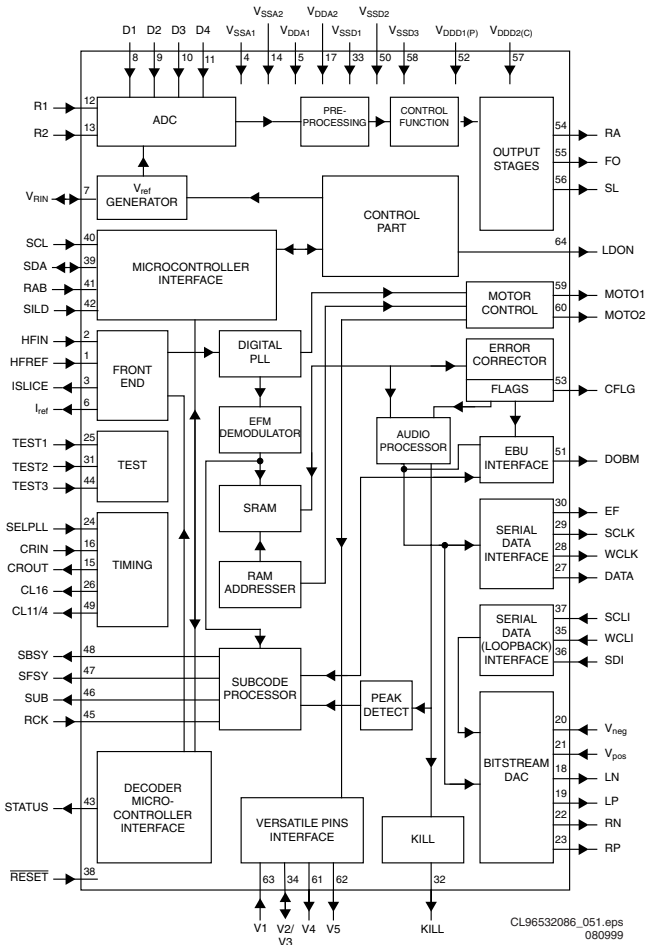

Figure 8-20

Pin Configuration

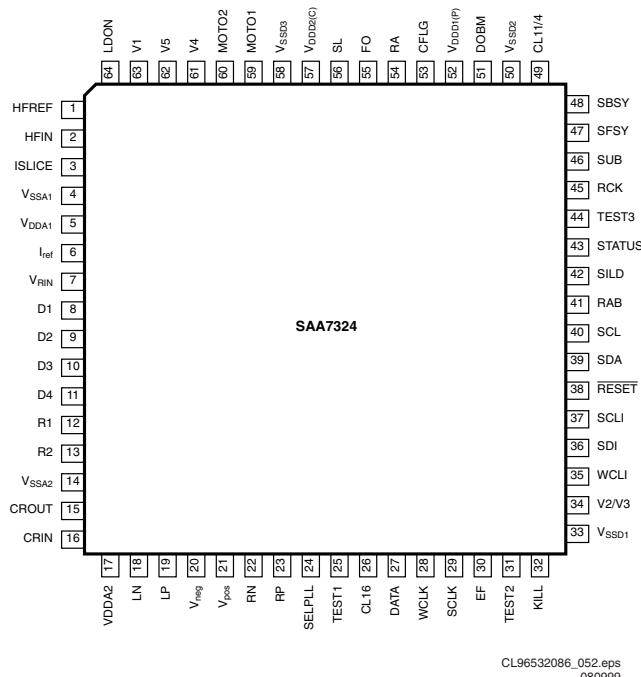

Figure 8-21

8.3.4 TDA7073A Power Drivers (7021, 7022)

Description

The TDA7073A is a dual power driver circuit for servo systems with a single supply. In this configuration it is used to drive the sledge, tray, focus and radial.

Measurements

Keep microprocessor 7202 in reset by forcing pin 7 of connector 1208 to +5V. Connect the power supply as described above in "1.1.1. Supply Voltages". Check the following voltages :

Pin	Location	Value
5	7021	12V ± 10%
5	7022	12V ± 10%
1	7022	1.65V ± 10%
2	7022	1.65V ± 10%
6	7022	1.65V ± 10%
7	7022	1.65V ± 10%
1	7021	5.0 ± 10%
2	7021	5.0 ± 10%
6	7021	1.65V ± 10%
7	7021	1.65V ± 10%

CL96532086_053.eps
080999

Figure 8-22

Pin	Location		Value DC
9	7022	FOC	5.8V ± 10%
12	7022	FOC	5.8V
13	7022	RAD	5.8V
16	7022	RAD	5.8V
9	7021	SLE	5.8V
12	7021	SLE	5.8V
13	7021	TRAY-	5.8V
16	7021	TRAY+	5.8V

CL96532086_054.eps
080999

Figure 8-23

8.3.5 BA6856FP Turn Table Motor Driver (7020)

Description

This component is a 3 phase, full wave pseudo linear driving system with inbuilt Hall Bias circuit and 3 phase parallel output.

Measurements

Keep processor 7202 in reset by forcing pin 7 of connector 1208 to +5V. The outputs 9, 10, 11 of connector 1006 are 0V. Pin 21 of the motor driver 7020 is 2.5V (10%). Pin 22 of the motor driver 7020 is 2.5V (10%). Pin 23 of the motor driver 7020 is 0V. Pin 19 of the motor driver 7020 is 5V (10%). Put the processor out of reset to continue the measurement. Check MOT1 at pin 59 of CD10. The duty cycle of the output should be 50%. Check wave form at pin 11 of 7005-D : amplitude 5V + 5% duty cycle 50%.

The motor driver 7020 can be measured dynamically by connecting a hall motor to the application panel. Apply a pulse of 1V 10Hz and 15% duty cycle to pin 22 (Ec) as input value with reference to pin 21 (Ecr=2.5V). Measure the output signals on the driver. This will give as response a square wave on pin 17 and pin 18. When a positive voltage

is applied, the square wave on pin 17 will go ahead of the square wave on pin 18.

All signals will have a value as shown in the truth table. Check the following output signals :

Motor controller truth table

Input conditions conn 1006 pin						Outputs conn 1006			Test points on driver		
6	8	4	7	3	2	9	10	11	18	17	16
U+	U-	V+	V-	W+	W-	UCOIL	VCOIL	WCOIL	HALL_U	HALL_V	HALL_W
L	M	H	M	M	M	6V	0V	0V	0V	5V	
H	M	L	M	M	M	0V	6V	6V	5V	0V	
M	M	L	M	H	M	0V	6V	0V		0V	5V
M	M	H	M	L	M	6V	0V	6V		5V	0V
H	M	M	M	L	M	0V	0V	6V	5V		0V
L	M	M	M	H	M	6V	6V	0V	0V		5V

CL96532086_055.eps
080999

Figure 8-24

Hall-elements input signal voltage levels

Input voltage	Level	Tolerance	Unit
H	2.8	0.1	V
M	2.5	0.1	V
L	2.2	0.1	V

CL96532086_056.eps
080999

Figure 8-25

8.3.6 Tray Control

Description

The tray control consists of a TDA7073A power driver (7021) controlled by the processor 7202 via pin 19 TRAYIN and pin 20 TRAYOUT. If pin 20 is low and pin 19 high, the TRAY+ signal at pin 16 of 7021 is forced to +8V and the TRAY- signal at pin 13 of 7021 to GND : the tray will open. If pin 20 is high and pin 19 low, TRAY+ becomes GND and TRAY- becomes +8V : the tray will close. If pin 19 and 20 of the processor have the same value, TRAY+ and TRAY- will have the same value as well : the tray stops moving.

Measurements

Keep processor 7202 in reset by forcing pin 7 of connector 1208 to +5V. Connect a load of 15Ω, 7W between pin 3 and 4 of connector 1002. Check the voltage over the load with TRAY+ (pin 3) as positive reference. Check also the levels of pins 19 and 20 of the processor.

U TRAY+,TRAY- = <100mV

Pin 20 = +5V

Pin 19 = +5V

Force pin 20 of the processor to ground, and check the voltages.

U TRAY+,TRAY- = -6.5V(10%)

Pin 20 = +0V

Pin 19 = +5V

Force pin 19 of the processor to ground as well and check the levels again.

U TRAY+,TRAY- = <100mV

Pin 20 = +0V

Pin 19 = +0V

Release pin 20 of the processor and check the levels.

U TRAY+,TRAY- = 6.5V(10%)

Pin 20 = +5V

Pin 19 = +0V

Release pin 19 of the processor and check the levels again:

U TRAY+,TRAY- = <100mV

Pin 20 = +5V

Pin 19 = +5V

8.3.7 HF Path

Description

The pre-amplified HF-signal is presented to both n=1 and n=2 amplifier circuits. The mux/demux switches via software and micro processor controlled S1 and S2 lines between either one of the amplified n=1 or n=2 signals. The signal will

then follow another amplification and filtering circuit. The filtering again is controlled by the S1 and S2 lines, dependant on whether the disc starts up (speed n=1, S1 and S2 Low), disc plays at speed n=1 (S1 Low, S2 High) or disc plays at speed n=2 (S1 and S2 High).

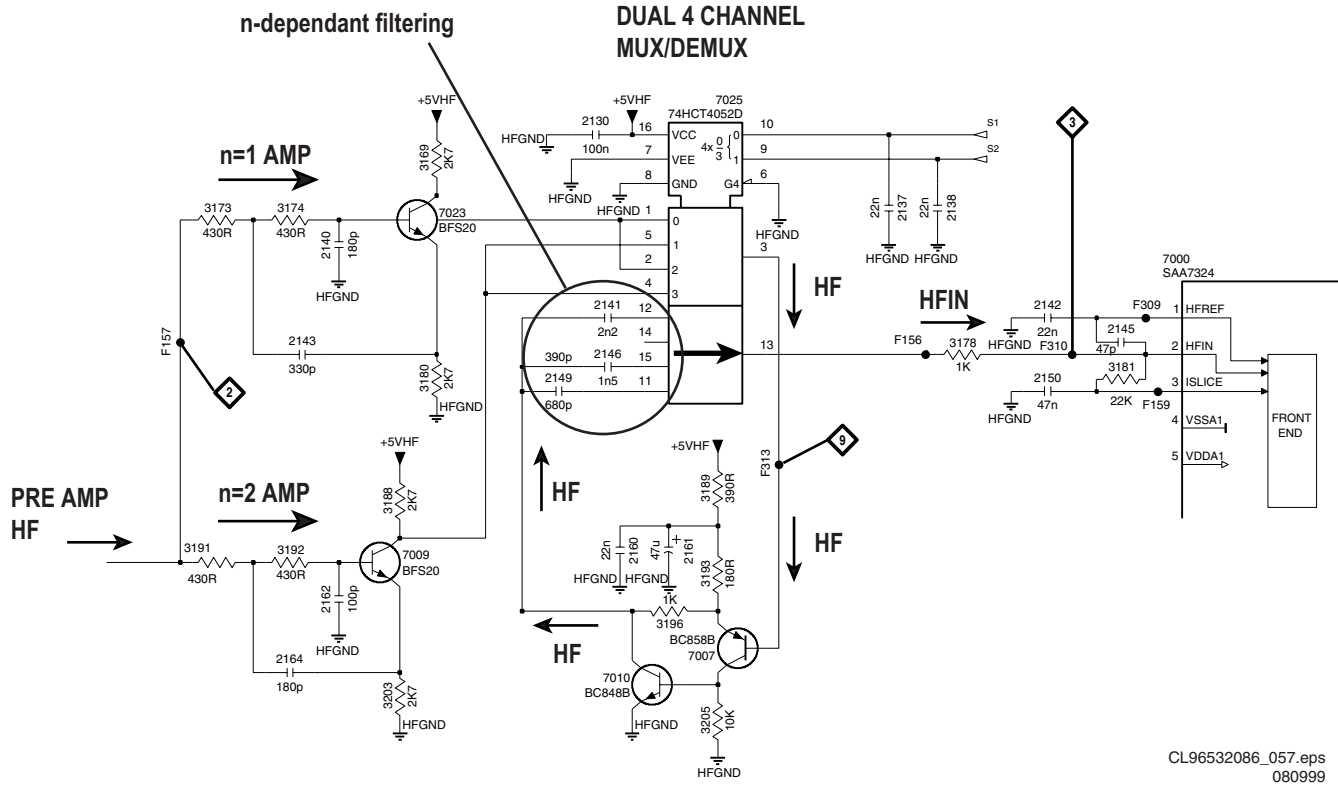

CL96532086_057.eps
080999

Figure 8-26

DC Settings

Set the power and reset connections as described above in "1.1.1.1. Supply Voltages". Check the following voltages :

Force	Pin	Location	Measure
	Emitter	7006	2.4 ± 10%
S1 and S2 "HIGH"	Collector	7010	1.9 ± 10%
S1 and S2 "LOW"	Collector	7010	1.9 ± 10%
S1 and S2 "HIGH"	13	7025	1.6 ± 10%
S1 and S2 "LOW"	13	7025	1.6 ± 10%
S1 and S2 "HIGH"	3	7025	3.2 ± 10%
S1 and S2 "LOW"	3	7025	3.2 ± 10%

CL96532086_058.eps
080999

Figure 8-27

Transfer Characteristics

Set the power and reset connections as described above in "1.1.1. Supply Voltages". Connect a function generator via a serial resistor of 1k5 to pin 4 of connector 1000. Use the

function generator as a sine wave generator with output level of 1Vtt. Check this AC value with an AC mV-meter connected to the input (pin 2) of the CD10 (7000) :

Frequencies	S1 and S2 "low"		S1 and S2 "high"	
	Input V _{ac}	Pin 2 at 7000	Input V _{ac}	Pin 2 at 7000
300 Hz	200mV	< 100mV ± 20%	200mV	< 100mV ± 20%
10 kHz	200mV	295mV ± 20%	200mV	330mV ± 20%
100 kHz	200mV	310 mV ± 20%	200mV	330 mV ± 20%
300 kHz	200mV	385 mV ± 20%	200mV	335 mV ± 20%
800 kHz	200mV	655 mV ± 20%	200mV	485 mV ± 20%
1.5 MHz	200mV	1.1V ± 20%	200mV	760 mV ± 20%
3MHz	200mV	1.1V ± 20%	200mV	1.1V ± 20%

CL96532086_059.eps
080999

Figure 8-28

HFDET Setting

Set the power and reset connections as described above in "1.1.1. Supply Voltages". Connect a function generator via a serial resistor of 1k5 to pin 4 of connector 1000. Use the

function generator as a sine wave generator with output level of 500 kHz, 1Vtt. Check this AC value with an AC mV-meter :

Location	Voltage DC		Voltage AC
	No HF	HF	
F190	4.8V± 20%	4.8V± 20%	175mV± 20%
F192	< 100mV	1.1V± 20%	-
F206	4.9V± 20%	150mV± 20%	-

CL96532086_060.eps
080999

Figure 8-29

8.3.8 Audio Part - DAC

Description

The DAC used, is the UDA1320 bit stream, continuous calibration. I2S signals from various formats can be entered at pins 1,2 and 3. If these signals are in phase with the delivered system clock at pin 6, the DAC will reproduce analog output signals at pins 14 and 16. 0dB level is 0.85Vrms. These analog signals are at 1.65Vdc level. The DAC has features which can be checked on the input pins. Mute will switch off the analog signals. De-emphasis is not used, since this is done in the decoder. Attenuation of -12dB is not used because this is also done in the decoder.

I2S

I2S is a kind of digital audio format, consisting out of 3 lines : CLOCK, WORDSELECT and DATA.

WORD-SELECT

Word select (WS) indicates whether the data-sample is from the left or the right audio-channel. It has the same frequency as the sample rate of the digital audio signal. This can be 32, 44.1 or 48kHz. Normal polarity is low for a left sample and high for a right sample. So within the low state of the WS-line the data bits for the left channel are transferred, and within the high state the data bits of the right channel are transferred.

CLOCK

The CLOCK signal (CLK) indicates when DataTips must be set, and when DataTips must be read. The frequency depends on the speed of the I2S-bus, but is always a factor of the frequency of the WS-signal. It can be 48x, 64x, 96, 128x... .In our case it is 48x the sample rate frequency = 2.1168MHz. The signal is in phase with the WS-signal.

Transition of the WS always happens on a falling edge of the CLK.

DATA

DATA contains all data-bits. Data bits are set by the transmitting device, and read by the receiving device. The position of the DATA-bits within the WS-signal is very important. There are several formats for this. In our case we always use Philips I2S format, no Japanese or Sony format. The number of data-bits per channel depends on the used devices.

Timing of the I2S-bus, in case of Philips I2S is shown in the next figure :

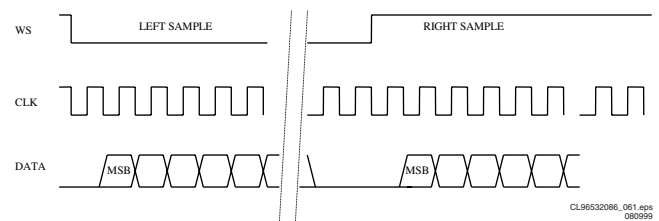

CL96532086_061.eps
080999

Figure 8-30

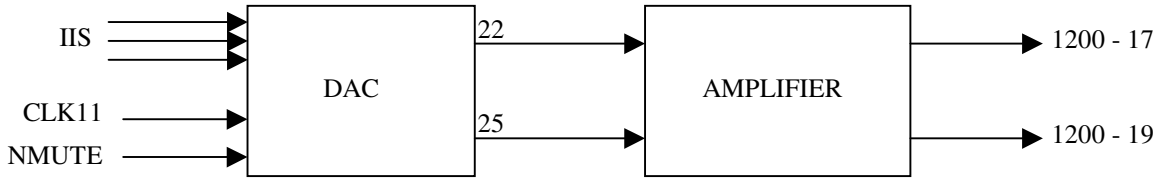
Measurements

CL96532086_062.eps
080999

Figure 8-31

Keep processor 7202 in reset by forcing pin 7 of connector 1208 to +5V. This puts the processor outputs in tristate. Check the reset at pin 4 of processor 7202 to make sure that the processor is in reset.

Now, force port 0-4 pin 33 at 7202 to 0V to set the decoder outputs (SCLK, WCLK, DATA, and CL11).

Check the MUTE pin 11 at 7309 : this pin should be low.

Connect via an I2S generator I2S-signals to the DAC :

Pin 1 at 7309: SLCK.

Pin 2 at 7309: WCLK.

Pin 3 at 7309: DATA.

Connect also the SYSCLK pin 6 at position 7309 to a clock signal of 11.2896 MHz (100ppm).

Generate an I2S signal equivalent with a sine wave of 1kHz at 0dB for both left and right channels.

Check if 0.8 VRMS at pins 14 and 16 at location 7209 with a DC of 1.65VDC.

Check if 1.7 VRMS (2 dB at connector pins 1 and 3 at location 1209.

Force MUTE Pin 11 at 7309 high.

Measure again at pins 1 and 3 at location 1209 : both signals should be at -90 dB.

9. List of Abbreviations

SIGNAL NAME	SIGNAL FLOW	FUNCTION AND DESCRIPTION
+12V	main supply voltage from PSU	+12V supply voltage from PSU
+12VA	supply voltage	+12V supply voltage for Audio part
+5V	main supply voltage from PSU	+5V supply voltage from PSU
+5VA	supply voltage	+5V supply voltage for Audio part
+9SRVPWR	IC7558 -> IC7240	PoWeR supply for SeRVo driver IC
12VPWR	supply voltage	+12V supply voltage for servo part
-8V	main supply voltage from PSU	-8V supply voltage from PSU
-8VA	supply voltage	-8V supply voltage for Audio part
A(1:20)	IC7701 -> R3818, R3819, R3820, R3821, R3897 -> IC7703	Address lines 1 to 20 between DASP and flash ROM
A(10:20)	IC7701 -> R3819, R3820, R3821 -> IC7702	Address lines 10 to 20 between DASP and DRAM
A1	IC7010 -> IC7270	amplitude of the "land" reflection relative to the average EFM, voltage output, OPC input
A1LF, A2LF	CONN1000 -> IC7010	satellite photo diodes A1, A2 current output
A2	IC7010 -> IC7270	amplitude of the "pit" reflection relative to the average EFM, voltage output, OPC input
A-8V	supply voltage	-8V supply voltage for servo part
AEGER		Analog Error signal GEnerator for Recordable
AINTON	IC7008 -> IC7010	Alpha INTEgrator ON (to AEGER)
ALE	IC7270 -> R3213 -> IC7209, IC7300IC7270 -> R3230	Address Latch Enable; external address latch strobe line, freeze address when low
ALPHA0	IC7270 -> IC7010	analog voltage mode output from OPC D/A converter
ALS	IC7008 -> IC7010	Alpha Loop Switch (to AEGER)
ASTROBE	IC7008 -> IC7010	Alpha STROBE (to AEGER)
ATIP		Absolute Time In Pre-groove (sync signal)
ATIPSYNC	IC7300 -> IC7270	ATIP SYNC signal
ATT	IC7270 -> R3717, R3722IC7270 -> IC7701	ATTenuation request from MACE2 to audio DAC, active low; means that the output can be attenuated in case of search activities
B1LF, B2LF	CONN1000 -> IC7010	satellite photo diodes B1, B2 current output
BCLK	IC7701 -> R3898A -> IC7300	I2S1 BitCLock from DASP to CDR60 (playback and record)
BE_RESET	IC7701 -> R3261 -> IC7270IC7701 -> R3716	Basic Engine RESET, active high
BIASC	IC7008 -> R3056	BIAS Current switch CDRW output
BKPT	CONN1819, R3907 -> IC7701	JTAG mode select / debug mode BreAKePoinT
C1LF, ... , C4LF	CONN1000 -> IC7010	Central photo diodes C1, C2, C3, C4 current output
CAGAIN	R3016, R3115 -> IC7010	set-point laser power on disc, current input
CAHF	CONN1000 -> C2374	Central Aperture (central photo diodes) High Frequency current output (C1+C2+C3+C4)
CALF	IC7010 -> IC7270	Central Aperture (central photo diodes) Low-pass Filtered signal (DC coupled EFM signal), voltage output, OPC input
CAS0	IC7701 -> IC7702	Column Address Strobe DRAM for upper byte
CAS1	IC7701 -> IC7702	Column Address Strobe DRAM for lower byte
CDR	IC7008 -> IC7355	CDR strategy detected output (active high)
CDR60CFLG	IC7300 -> R3382B -> CONN1812	serial output of error corrector status information of the CDR60-decoder, to be measured at test connector
CDR60CL1	IC7300 -> R3382C -> CONN1812	output of CLock signal for testing system clock of IC CDR60 at test connector
CDR60CS	IC7270 -> R3235B -> R3702, IC7300	CDR60 Chip Select, active high
CDR60INT	IC7300 -> IC7270	CDR60 INTerrupt line, active low
CDR60LWRT	IC7300 -> R3048	CDR60 Laser WRITe control output
CDR60MEAS1	IC7300 -> R3382A -> CONN1812	serial output of information about jitter, PLL frequency and asymmetry of bit recovery block in CDR60, to be measured at test connector

CDR60PLL	IC7270 -> R3305 -> IC7300	CDR60 clock multiplier enable, active high
CDRW	IC7355D -> IC7355CIC7355D -> CONN1000	inverted CDR-strategy-detected signal
CLK_OUT	IC7701 -> R3771 -> CONN1819	system CLoCK OUT
CLK_SYS	IC7701 -> R3727, R3731	oscillator output
COS-	CONN1220 -> IC7225B	Hall feedback signal from sledge motor
COS+	CONN1220 -> IC7225B	Hall feedback signal from sledge motor
CSFLASH	IC7701 -> IC7703	Chip Select for FLASH or boot device
CSRAM	IC7270 -> R3235A -> R3703, IC7802	Chip Select SRAM, active low
D(16:31)	IC7701 <-> R3822, R3823, R3824, R3825 <-> IC7703, IC7702	Databus bit 16 to 31 between DASP, flash ROM and DRAM
D3V3	supply voltage	+3,3V supply voltage for Digital part
D5V	supply voltage	+5V supply voltage for Digital part
D5VS	supply voltage	+5V supply voltage for Servo part
DALPHA	IC7010 -> R3037	ALPHA error signal for laser power control
DASP		Digital Audio Signal Processor
DATAI	IC7701 -> R3898C -> IC7300	I2S1 DATA In from DASP to CDR60 (recording)
DATAO	IC7300 -> R3314 -> IC7701	I2S1 DATA Out from CDR60 to DASP (playback)
DEEMP	IC7270 -> R3719, R3724IC7270 -> IC7701	DE-EMphasis control for audio DAC from MACE2, active high; means that de-emphasis is needed in digital filter
DELTAP	IC7016 -> R3126	DELTA Power current source drive signal from XDAC
DIG_OUT_C	IC7701 -> R3706 -> C2707, CONN1400	Common DIGital OUTput (consumer)
DISPLAY_INT	F934 -> R3812, IC7701	DISPLAY INTerrupt
DMON	IC7270 -> R3324	power save at stop, active low
DOBM_CD	CONN1708, C2731 -> R3757 -> R3903 -> IC7701	Digital Output (EBU output) from CD player in CDR779 to DASP
DOBM_CDR	IC7300 -> R3382D -> C2379, IC7701	Digital Output (EBU output) from CDR60 to DASP
DRAM_RW	IC7701 -> IC7702	Read/Write strobe for DRAM
DSA_ACK_CD	IC7701 <-> R3830 <-> R3831 <-> CONN1708IC7701 <-> R3830 <-> C2735	Data/Strobe/Acknowledge serial communication between DASP and CD-player in CDR779
DSA_ACK_CD R	IC7701 -> R3729 -> IC7270, CONN1830IC7701 -> R3729 -> R3769	Data/Strobe/Acknowledge serial communication between MACE2 and DASP for CDR; acknowledge input for MACE2 is strobe output for DASP
DSA_DATA_CD	IC7701 <-> R3828 <-> R3829 <-> CONN1708IC7701 <-> R3828 <-> C2733	Data/Strobe/Acknowledge serial communication between DASP and CD-player in CDR779
DSA_DATA_CD R	IC7270<->R3246 <-> R3813 <-> IC7701, CONN1830IC7270<->R3246 <-> R3767	Data/Strobe/Acknowledge serial communication between MACE2 and DASP for CDR
DSA_STR_CD	IC7701 <-> R3835 <-> R3832 <-> CONN1708IC7701 <-> R3835 <->C2734	Data/Strobe/Acknowledge serial communication between DASP and CD-player in CDR779
DSA_STR_CD R	IC7270 -> R3245 -> IC7701, CONN1830IC7270 -> R3245 -> R3768	Data/Strobe/Acknowledge serial communication between MACE2 and DASP for CDR (strobe output for MACE2 is acknowledge input for DASP)
DSCLK	CONN1819, R3908 -> IC7701	reset in / Debug Serial CLoCK in
DSI	CONN1819, R3909 -> IC7701	JTAG reset in / Debug Serial clock In
EFM		Eight to Fourteen Modulation = modulation method used for CD storage, also the actual raw CD signal as written or read on or from the CD disc
EFMCLK	IC7300 -> IC7008	EFM CLoCK output
EFMDATA	IC7300 -> IC7008	EFM DATA output
EFMTIM3		EFM TIMing generator
EPON	IC7008 -> R3010IC7008 -> C2010	Erase Power ON
EPONO	IC7008 -> R3107	Erase Power ON Open drain output
EPONRC	R3004 -> CONN1000	Erase Power ON (after RC circuit)
ERASEC	IC7008 -> R3087	ERASE Current switch CDRW output
ERON	IC7008 -> IC 7010	ERror ON (to AEGER)
EXT_DIG_IN1	CONN1400 -> IC7701	EXTernal DIGital INput 1

EXT_DIG_IN2	CONN1702, C2767, C2721 -> R3701 -> IC7701	EXTErnal DIGItal INput 2 (CDR779 only)
EXT_OPT_IN	CONN1400, C2722 -> R3708 -> IC7701	EXTErnal OPTIcal INput
F_READY	IC7703 -> R3817 -> IC7701 CONN1701 -> IC7701	Flash READY detection, this line is forced low as long as the flash is busy with erase or program algorithm
F_RW	IC7701 -> IC7708B	Read/Write strobe for Flash ROM
FEN	IC7010 -> IC7270	Focus Error Normalized current output
FOC-	IC7240 -> CONN1000	FOCUS actuator drive signal negative connection
FOC+	IC7240 -> CONN1000	FOCUS actuator drive signal positive connection
FS30V	D6500 -> CONN1000	Forward Sense diode 30V power supply
FSA	CONN1000 -> T7119, T7120	Forward Sense photo diode current output
FSCLR	IC7008 -> IC7126	Forward Sense signals CLEAR switch
FSOF	IC7008 -> R3052	Forward Sense photo diode sampling OFF
FSON	IC7008 -> R3051	Forward Sense photo diode sampling ON
FSR	R3040 -> IC7270	Forward Sense signal while Reading for read control loop
FSRS	IC7008 -> IC7126D	Forward Sense photo diode Read Sampling
FSW	R3050 -> IC7270	Forward Sense signal while Writing for write control loop
FSWS	IC7008 -> IC7126C	Forward Sense photo diode Write Sampling
FWEN	IC7270 -> IC7208, R3806	Flash EPROM Write ENable
HALL_U, HALL_V, HALL_W	IC7330 -> IC7300, CONN1812	HALL feedback signals from turn table motor via hall motor driver
HFS0	IC7270 -> R3249 -> IC7360	select HF circuit
I2C		Inter IC
I2C_CLK	IC7701, R3711 -> R3715 -> C2709 -> F934 IC7701, R3711 -> IC7801	I2C CLock line used for display slave processor and digital potmeter
I2C_DATA	IC7701, R3712 <-> R3713 <-> C2708, R3714 <-> F934 IC7701, R3712 <-> IC7801	I2C DATA line used for display slave processor and digital potmeter
I2CL	R3248B -> IC7207, R3247C	I2C CLock line
I2CSCL	IC7207 -> IC7008 IC7207 -> IC7010 IC7207 -> R3248B	I2C Serial CLock line
I2CSDA	IC7207 <-> IC7008 IC7207 <-> IC7010 IC7207 <-> R3248A	I2C Serial DATA line
I2DA	R3248A <-> IC7270, R3247D	I2C DATA line
I2S_BCLK_AI	IC7701 -> R3814 -> IC7406	I2S4 Bit CLock for CODEC (ADC for CDR779) Analog Input (record from analog source)
I2S_BCLK_AO	IC7701 -> R3894A -> IC7406	I2S2 Bit CLock for CODEC (DAC for CDR779) Analog Output
I2S_BCLK_CD	CONN1708, C2739 -> R3834 -> IC7701	I2S3 Bit CLock from CD player (record n=2) (CDR779 only)
I2S_BCLK_MIC	CONN1708, C2739 -> R3834 -> IC7701	I2S3 Bit CLock from MICrophone (CDR779 only)
I2S_DATA_AI	IC7406 -> IC7701	I2S4 DATA from CODEC (ADC for CDR779) Analog Input (record from analog source)
I2S_DATA_AO	IC7701 -> R3894C -> IC7406	I2S2 DATA for CODEC (DAC for CDR779) Analog Output
I2S_DATA_CD	CONN1708, C2738 -> R3836 -> IC7701	I2S3 DATA from CD player (record n=2) (CDR779 only)
I2S_DATA_MIC	CONN1708, C2738 -> R3836 -> IC7701	I2S3 DATA from MICrophone (CDR779 only)
I2S_WS_AI	IC7701 -> R3743 -> IC7406	I2S4 Word CLock for CODEC (ADC for CDR779) Analog Input (record from analog source)
I2S_WS_AO	IC7701 -> R3894B -> IC7406	I2S2 Word CLock for CODEC (DAC for CDR779) Analog Output
I2S_WS_CD	CONN1708, C2740 -> R3833 -> IC7701	I2S3 Word CLock from CD player (record n=2) (CDR779 only)
I2S_WS_MIC	CONN1708, C2740 -> R3833 -> IC7701	I2S3 Word CLock from MICrophone (CDR779 only)
I2S1_MS	IC7270 -> R3910, IC7701	I2S1 Master-Slave interrupt from MACE2
IE	T7121 -> CONN1000	laser Erase drive current signal
INT_COPY_AN A	IC7701 -> R3721 -> IC7401 IC7701 -> R3721 -> R3410	select INTERNAL COPY ANALog (in case of copy protected disc or track on CD drive) (CDR779 only)
IR	T7135 -> CONN1000 T7135 -> R3056 T7135 -> IC7008	laser Read drive current signal
IW	T7122 -> CONN1000 T7122 -> D6003	laser Write drive current signal

KEY_PRESSED	IC7706B -> R3816 -> IC7701	KEY PRESSED interrupt
KILL	T7560, T7561, R3560 -> CONN1400, R3424, R3428	KILL signal from power supply part to audio outputs
KILL_OUT	IC7701 -> R3532	disables the KILL activity from the PSU; 1 = no kill, 0 = kill active
L12V	supply voltage	+12V supply voltage for servo/Laser part
L3_CLK	IC7701 -> R3725 -> IC7406	L3 interface CLock line / control CODEC (not for CDR779)
L3_DATA	IC7701 <-> R3728 <-> IC7406	L3 interface DATA line with CODEC (not for CDR779)
L3_MODE	IC7701 -> R3735 -> IC7406	L3 interface MODE line selects data or address transfer mode for CODEC (not for CDR779)
L5V	supply voltage	+5V supply voltage for servo/Laser part
L-5V	supply voltage	-5V supply voltage for servo/Laser part
LASCK	IC7270 <-> R3248D	Clock line DAC LASer control
LASDACCK	R3248D <-> IC7016	Clock line DAC LASer control
LASDACDI	R3248C <-> IC7016	Data line DAC LASer control
LASDACLD	R3212 <-> IC7016	Load line DAC LASer control
LASDD	IC7270 <-> R3248C	Data line DAC LASer control
LASLD	IC7270 <-> R3238 <-> R3212IC7270 <-> R3232	Load line DAC LASer control
LEFT	CONN1708, C2743 -> IC7401C, IC7407C	audio output LEFT channel from CD-player in CDR779
LLP	IC7270 -> IC7300	Laser Low Power (active high), switches the laser from write to read power whenever the device tends to go offtrack
LWRT	R3048 -> IC7008	Laser WRITe control input
MA(16:17)	IC7270 <-> IC7208	bank switch higher address lines
MA(8:15)	IC7270 <-> IC7802 <-> IC7208	address bus high byte
MACE2		Mini All Cd Engine (minus decoder + OPC + PCS + extra RAM)
MAD(0:7)	IC7270 <-> IC7209 <-> IC7802 <-> IC7208 <-> IC7300	bi-directional data bus / address bus low byte
MIRN	IC7010 -> IC7270	MIRror Normalized (disc reflection) current output
MOTO1	IC7300 -> IC7355A	turn table MOTO control output
MRDN	IC7270 -> R3276 -> R3242A, IC7802, IC7300	Master ReaD, read strobe for external peripherals, active low
MUTE	IC7270 -> R3718, R3723IC7270 -> IC7701	MUTE control from MACE2 to DASP, active low
MWRN	IC7270 -> R3280 -> R3242B, IC7802, IC7300	Master WRite, write strobe for external peripherals, active low
NMUTE	IC7701 -> R3726, IC7406	MUTE output, low active
OFFTRACK	IC7270 -> IC7300	OFFTRACK detection flag
OPC		Optimum Power Calibration
P12VKILL	supply voltage	+12V supply voltage for KILL-circuit
PCS		Position Control Sledge
PCSCOS	IC7225B, C2229 -> IC7270, CONN1812	Position Control Sledge COS feedback signal
PCSSIN	IC7225A, C2227 -> IC7270, CONN1812	Position Control Sledge SIN feedback signal
PDAR		Photo Diode Amplifier Recordable
PERASE	R3036, R3031, R3030, R3029, R3028, R3027, R3020 -> IC7002C, R3043, T7113	laser Power switch for ERASE
POWER_UP	IC7270 -> R3243C, R3556, R3538	standby pin, high level activates essential powers necessary for full function; overrules HI_POWER setting
PPN	IC7010 -> IC7050C	Push-Pull signal, Normalized, balanced, voltage output
PRCOARSE	IC7016 -> R3057	drive signal from Power Read COARSE DAC for read current source
PRFINE	IC7016 -> R3058	drive signal from Power Read FINE DAC for read current source
PROF_EBU	IC7701 -> CONN1820	PROFessional digital output (CDR779 only)
PSEnN	IC7270 -> R3260 -> IC7208IC7270 -> R3231	Program Store ENable; external ROM output enable line, active low
PW	R3081 -> IC7008	Write Power signal to OPC input of MACE2

PWB	IC7001C -> IC7016	drive signal to XDAC<->s for write and erase current sources and VCAGAIN
PWD	IC7016 -> IC7002BIC7016 -> IC7002C	drive signal from XDAC for write and erase current sources
PWMAX	IC7016 -> R3073	PW MAXimum signal from DAC used for determining set point for laser power during writing
PWMIN	IC7016 -> R3072	PW MINimum signal from DAC used for determining set point for laser power during writing
PWRITE	R3035, R3026, R3025, R3024, R3023, R3022, R3021 -> IC7002B, R3044, T7124	laser Power switch for WRITE
RAD-	IC7240 -> CONN1000	Radial actuator drive signal negative connection
RAD+	IC7240 -> CONN1000	Radial actuator drive signal positive connection
RAS0	IC7701 -> IC7702	Row Address Strobe DRAM
RCK	IC7300 -> R3319 -> IC7701	EIAJ subcode clock from CDR60 to DASP (CD text interface)
RDGAIN1	IC7008 -> R3054	forward sense ReaD GAIN switch 1
RDGAIN2	IC7008 -> C2027	forward sense ReaD GAIN switch 2
RDGAIN3	IC7008 -> C2060	forward sense ReaD GAIN switch 3
RE	IC7010 -> IC7215A	Radial Error signal for fast track counting, voltage output
RECORDING	IC7008 -> IC7010IC7008 -> CONN1000IC7008 -> IC7355C	RECORDING output (active high)
REN	IC7010 -> IC7270	Radial Error Normalized current output
RIGHT	CONN1708, C2742 -> IC7401A, IC7407A	audio output RIGHT channel from CD-player in CDR779
RXD_TOOL	CONN1818 -> IC7701	Receive of UART for test TOOL
S1V65	Referenve Voltage	1.65V delivered by IC7215B for Servo part
S2V9	Reference Voltage	2.9V delivered by IC7010 for Servo part
SEL_HP_OUT	IC7701 -> R3720 -> IC7407	SElect HeadPhone OUTput in DJ-mode (for CDR779 only)
SFSY	IC7701 -> R3756 -> IC7300	EIAJ subcode synchronisation from DASP to CDR60 (CD text interface)
SIN-	CONN1220 -> IC7225A	Hall feedback signal from sledge motor
SIN+	CONN1220 -> IC7225A	Hall feedback signal from sledge motor
SL-	IC7240 -> R3265 -> CONN1220	SLedge motor drive signal negative connection
SL+	IC7240 -> CONN1220	SLedge motor drive signal positive connection
SRSTN	IC7270 -> R3243B, IC7300	Slave ReSeT out (CDR60 reset), active low
STANDBY	IC7270 -> R3807 -> R3887 -> IC7701	STANDBY pin, high level activates essential powers necessary for full function; overrules HI_POWER setting
SUB	IC7701 -> R3710 -> IC7300	EIAJ subcode data from DASP to CDR60 (CD text interface)
SYS_CLK_11W	IC7701 -> R3732 -> IC7406	11.2896 MHz SYStem CLoCK for AD/DA datapath
SYS_CLK_16W	IC7701 -> R3894D-> IC7706A	16.9344 MHz SYStem CLoCK for producing SYS_CLK_BE
SYS_CLK_8W	IC7706A -> R3815 -> CONN1708	SYStem CLoCK CD player (8.4672 MHz) (CDR779 only)
SYS_CLK_BE	IC7706A -> R3826 -> IC7270	SYStem CLoCK Basic Engine (8.4672 MHz)
SYS_RESET	IC7701 -> R3758 -> CONNF934IC7701 -> R3770 -> T7707 -> CONN1708	SYStem RESET to display assy (and CD player for CDR779)
TCK	CONN1819 -> R3906, IC7701	JTAG CloCk signal
TDSO	IC7701 -> CONN1819	JTAG Serial Data Out / debug data out
TERMB	IC7270 <-> CONN1818	UART connection with MACE
TLN	IC7010 -> IC7270	Track Loss Normalized current output
TR-	IC7240 -> CONN1200	TRay motor drive signal negative connection
TR+	IC7240 -> CONN1200	TRay motor drive signal positive connection
TRACE99_RXD	CONN1818 -> R3838, IC7701	TRACE99 test tool receive data
TRACE99_TXD	IC7701 -> CONN1818	TRACE99 test tool transmit data
TRAYIN	IC7270 -> IC7240	move TRAY IN line, active low
TRAYOUT	IC7270 -> IC7240	move TRAY OUT line, active low
TRAYSW	CONN1200 -> R3747CONN1200 -> R3748	TRAY SWitch signal from loader assy
TRAYSWF	R3748, C2214 -> IC7270	Filtered TRAY SWitch signal, low is completely out or in

TXD_TOOL	IC7701 -> CONN1818	Transmit of UART for test TOOL
U+, U-, V+, V-, W+, W-	CONN1330 -> IC7330	hall feedback signals from turn table motor to hall motor driver
UCOIL, VCOIL, WCOIL	IC7330 -> CONN1330	drive signals for turn table motor
VCAGAIN	IC7016 -> IC7005A	set-point laser power on disc, voltage output
VDC1	CONN1500 -> CONNF934	supply voltage for display assy
VDC2	CONN1500 -> CONNF934	supply voltage for display assy
VFO	IC7270 -> R3295 -> R3244	FOcus actuator drive output
VFTD	CONN1500 -> CONNF934	Voltage Fluorescent Tube Display (display assy)
VRA	IC7270 -> R3297 -> R3254	RAdial actuator drive output
VSL	IC7270 -> R3299 -> IC7240	SLedge actuator drive output
WCLK	IC7701 -> R3898B -> IC7300	I2S1 WordCLock from DASP to CDR60 (playback and record)
WOBBLE	IC7050C -> IC7300	analog WOBBLE signal of pre-groove detected by PPN-signal
WPON	IC7008 -> R3009IC7008 -> C2009	Write Power ON
WPONO	IC7008 -> R3106	Write Power ON Open drain output
WPONRC	R3003 -> CONN1000	Write Power ON (after RC circuit)
XDAC		multiplying DAC

10. Spare parts list

CDR779

Mechanical Parts

0001	3104 127 12900	FRONT COMPLETE ASSY CDR779
0003	3104 127 08710	KEY UNIT MIDDLE ASSY CDR779
0009	4822 410 11962	POWER BUTTON BLACK
0014	4822 459 10887	
0015	4822 454 13339	
0051	3104 124 05700	EASY JOG KNOB CDR779
0052	4822 492 51374	spring
0053	3104 124 05620	TRANSPARENT FRAME BUTTON
0054	3104 124 05620	TRANSPARENT FRAME BUTTON
0076	3104 144 05730	SUSPENSION
0077	3104 144 05730	SUSPENSION
0078	3104 144 05730	SUSPENSION
0079	3104 144 05730	SUSPENSION
0165	4822 442 01506	COVER
0251	4822 462 11174	LEG SILVER
0252	4822 462 11174	LEG SILVER
0253	4822 462 11174	LEG SILVER
0254	4822 462 11174	LEG SILVER
0301	4622 004 50290	Mains cord
0309	3104 125 23980	USER MANUAL CDR779
0312	4822 321 22611	CINCH GOLD L:1500
0313	4822 321 22611	CINCH GOLD L:1500
0317	3104 128 92730	GOLD PLATED CINCH CABLE 1M 75R
0318	3139 228 82010	RC282921/01
1003	3122 427 22000	PSU-CDR3-ECONOMY EURO 20PS202
1004	3104 128 06610	PB ASSY 4249 I/O CDR779
8005	3104 157 11230	CWAS FLEX 1MM 22 320 32S
8007	3104 157 11320	CWAS FLEX 1.25MM 7 300 32S
8010	3104 157 11480	CWAS FLEX 0,5MM 30 130

I/O board 4249

Miscellaneous

1101	4822 265 30987	BMT 7SR>CBL0,3-1,25
1201	4822 267 41064	YKC21
1205	4822 265 11287	4P
1207	4822 265 10482	YKC21
1208	4822 267 31626	YKC21
1401	4822 267 10666	30 P. FEM.

-II-

2100	5322 122 32448	10pF 5% 63V CASE
2101	5322 122 32654	63V 22nF PM10 R
2102	5322 122 32448	10pF 5% 63V CASE
2103	5322 122 32654	63V 22nF PM10 R
2104	5322 124 11919	47µF 20% 6.3V
2106	5322 122 32654	63V 22nF PM10 R
2107	5322 124 11919	47µF 20% 6.3V
2108	4822 124 22339	100UE 16V
2109	4822 124 22339	100UE 16V
2111	5322 122 32654	63V 22nF PM10 R
2112	5322 124 11919	47µF 20% 6.3V
2113	4822 122 33177	10nF 20% 50V
2114	2022 029 00359	TAnF SM TAJ 10V 4U7 PM10 R
2115	2022 029 00359	TAnF SM TAJ 10V 4U7 PM10 R
2116	4822 122 33177	10nF 20% 50V
2118	5322 122 32654	63V 22nF PM10 R
2119	4822 126 14585	100nF 10% 50V
2120	5322 124 11919	47µF 20% 6.3V
2121	2022 029 00359	TAnF SM TAJ 10V 4U7 PM10 R
2122	5322 122 32654	63V 22nF PM10 R
2123	5322 124 11919	47µF 20% 6.3V
2124	5322 122 32654	63V 22nF PM10 R
2125	5322 122 32268	63V 470P PM5
2126	5322 122 32268	63V 470P PM5
2127	5322 122 32268	63V 470P PM5
2128	5322 122 32268	63V 470P PM5
2129	5322 122 32448	10pF 5% 63V CASE

2130	2022 029 00359	TAnF SM TAJ 10V 4U7 PM10 R
2131	2022 029 00359	TAnF SM TAJ 10V 4U7 PM10 R
2132	5322 122 32448	10pF 5% 63V CASE
2133	4822 126 14585	100nF 10% 50V
2134	4822 126 14585	100nF 10% 50V
2136	4822 124 22339	100UE 16V
2137	4822 124 22339	100UE 16V
2140	5322 122 32448	10pF 5% 63V CASE
2141	5322 122 32654	63V 22nF PM10 R
2143	5322 122 32448	10pF 5% 63V CASE
2144	5322 122 32654	63V 22nF PM10 R
2145	5322 122 32654	63V 22nF PM10 R
2146	5322 124 11919	47µF 20% 6.3V
2149	5322 122 32654	63V 22nF PM10 R
2151	5322 122 32654	63V 22nF PM10 R
2152	5322 124 11919	47µF 20% 6.3V
2153	5322 122 32654	63V 22nF PM10 R
2154	5322 124 11919	47µF 20% 6.3V
2155	2022 029 00359	TAnF SM TAJ 10V 4U7 PM10 R
2201	4822 126 14585	100nF 10% 50V
2202	5322 122 32654	63V 22nF PM10 R
2203	5322 122 32654	63V 22nF PM10 R
2204	4822 126 12105	50V 33nF PM5
2205	4822 126 12105	50V 33nF PM5
2206	4822 124 23002	10µF 16V
2207	5322 122 32654	63V 22nF PM10 R
2208	5322 122 33538	150pF 2% 63V
2209	5322 122 32654	63V 22nF PM10 R
2210	5322 122 32654	63V 22nF PM10 R
2215	5322 122 32659	33pF 5% 50V
2216	5322 122 32659	33pF 5% 50V
2217	5322 122 32659	33pF 5% 50V
2218	5322 122 32659	33pF 5% 50V
2219	5322 122 32659	33pF 5% 50V
2220	5322 122 32659	33pF 5% 50V
2221	4822 126 14585	100nF 10% 50V
2222	5322 122 32654	63V 22nF PM10 R
2223	5322 122 32654	63V 22nF PM10 R
2224	4822 124 23002	10µF 16V
2225	4822 126 12105	50V 33nF PM5
2226	4822 126 12105	50V 33nF PM5
2313	5322 122 32654	63V 22nF PM10 R
2316	5322 122 32654	63V 22nF PM10 R
2317	5322 122 32654	63V 22nF PM10 R
2318	5322 124 11919	47µF 20% 6.3V
2319	5322 122 32654	63V 22nF PM10 R
2320	5322 124 11919	47µF 20% 6.3V
2321	5322 122 31647	1nF 10% 63V
2322	5322 122 31647	1nF 10% 63V
2326	4822 126 14585	100nF 10% 50V
2327	4822 126 14585	100nF 10% 50V
2400	4822 126 14585	100nF 10% 50V
2401	3198 030 74780	EL SM 35V 4U7 PM20 COL R
2402	4822 126 14585	100nF 10% 50V
2403	5322 124 11919	47µF 20% 6.3V
2404	4822 126 14585	100nF 10% 50V
2405	5322 124 11919	47µF 20% 6.3V
2406	4822 126 14585	100nF 10% 50V
2407	3198 030 74780	EL SM 35V 4U7 PM20 COL R
2408	4822 126 14585	100nF 10% 50V
2409	5322 124 11919	47µF 20% 6.3V
2410	4822 126 14585	100nF 10% 50V
2411	5322 124 11919	47µF 20% 6.3V
2412	4822 126 14585	100nF 10% 50V
2413	5322 122 32531	100pF 5% 50V
2414	5322 122 32531	100pF 5% 50V
2415	5322 122 32531	100pF 5% 50V
2416	5322 122 32531	100pF 5% 50V
2417	5322 122 32531	100pF 5% 50V
2418	5322 122 32531	100pF 5% 50V
2419	5322 122 32531	100pF 5% 50V
2420	5322 122 32531	100pF 5% 50V
2421	5322 122 32531	100pF 5% 50V
2422	5322 122 32531	100pF 5% 50V
2423	5322 122 32531	100pF 5% 50V
2424	5322 122 32531	100pF 5% 50V
2425	5322 122 32531	100pF 5% 50V
2426	5322 122 32654	63V 22nF PM10 R
2427	4822 126 14585	100nF 10% 50V
2428	4822 126 14585	100nF 10% 50V
2504	4822 124 22339	100UE 16V
2514	4822 124 22339	100UE 16V
2600	5322 124 11919	47µF 20% 6.3V
2601	4822 126 14585	100nF 10% 50V

2602	4822 122 33575	220pF 5% 63V CASE
2603	5322 126 10511	1nF 5% 50V
2604	5322 126 10511	1nF 5% 50V
2605	5322 126 10511	1nF 5% 50V
2606	4822 122 33575	220pF 5% 63V CASE
2607	4822 126 14585	100nF 10% 50V
2608	4822 124 23002	10µF 16V
2609	4822 126 14585	100nF 10% 50V
2610	4822 124 23002	10µF 16V
2611	5322 124 11919	47µF 20% 6.3V
2612	4822 126 14585	100nF 10% 50V
2613	4822 122 33575	220pF 5% 63V CASE
2614	4822 126 14585	100nF 10% 50V
2615	5322 124 11919	47µF 20% 6.3V
2616	5322 126 10511	1nF 5% 50V
2617	5322 126 10511	1nF 5% 50V
2618	5322 126 10511	1nF 5% 50V
2619	4822 126 14585	100nF 10% 50V
2620	5322 124 11919	47µF 20% 6.3V
2621	4822 122 33575	220pF 5% 63V CASE
2622	4822 126 13693	56pF 1% 63V
2623	4822 126 13693	56pF 1% 63V
2624	4822 126 13693	56pF 1% 63V
2625	4822 126 13693	56pF 1% 63V
2626	2022 029 00359	TAnF SM TAJ 10V 4U7 PM10 R
3100	4822 117 10833	10k 1% 0.1W
3101	2322 750 64709	RST SM FUSE 1206 47Ω PM5 R
3102	4822 117 13623	51k 1% 0.1W RC12H 0805
3104	2322 750 64709	RST SM FUSE 1206 47Ω PM5 R
3105	4822 051 20008	0Ω jumper . (0805)
3106	4822 051 20472	4k7 5% 0.1W
3108	4822 117 10354	22k 1% 0.1W
3109	4822 116 83933	15k 1% 0.1W
3110	4822 117 10833	10k 1% 0.1W
3111	2322 750 64709	RST SM FUSE 1206 47Ω PM5 R
3112	4822 117 11507	6k8 1% 0.1W
3113	4822 117 12519	47Ω 1% 0.1W
3114	4822 117 11145	4k7 1% 0.1W
3115	4822 117 11145	4k7 1% 0.1W
3116	4822 117 10833	10k 1% 0.1W
3117	4822 051 20332	3k3 5% 0.1W
3118	4822 117 11142	2k4 1% 0.1W
3119	4822 117 13623	51k 1% 0.1W RC12H 0805
3120	4822 117 12991	1k6 1% 0.1W 0805 RC12H
3122	2322 750 64709	RST SM FUSE 1206 47Ω PM5 R
3123	4822 117 11145	4k7 1% 0.1W
3124	4822 117 13623	51k 1% 0.1W RC12H 0805
3125	4822 117 10833	10k 1% 0.1W
3126	4822 117 11145	4k7 1% 0.1W
3127	2322 750 64709	RST SM FUSE 1206 47Ω PM5 R
3128	4822 117 11152	4Ω 7 5%
3129	2322 750 64709	RST SM FUSE 1206 47Ω PM5 R
3130	2322 750 64709	RST SM FUSE 1206 47Ω PM5 R
3131	4822 117 10354	22k 1% 0.1W
3132	4822 117 10833	10k 1% 0.1W
3133	4822 116 83933	15k 1% 0.1W
3134	4822 117 13623	51k 1% 0.1W RC12H 0805
3135	4822 117 10833	10k 1% 0.1W
3136	4822 117 11507	6k8 1% 0.1W
3137	4822 117 13623	51k 1% 0.1W RC12H 0805
3138	4822 117 11145	4k7 1% 0.1W
3139	4822 051 20332	3k3 5% 0.1W
3140	4822 117 13623	51k 1% 0.1W RC12H 0805
3141	4822 117 11142	2k4 1% 0.1W
3142	4822 117 10833	10k 1% 0.1W
3143	4822 117 10833	10k 1% 0.1W
3144	4822 117 12991	1k6 1% 0.1W 0805 RC12H
3146	2322 750 64709	RST SM FUSE 1206 47Ω PM5 R
3147	4822 117 13623	51k 1% 0.1W RC12H 0805
3148	4822 117 13623	51k 1% 0.1W RC12H 0805
3149	4822 117 10833	10k 1% 0.1W
3150	4822 117 13623	51k 1% 0.1W RC12H 0805
3151	2322 750 64709	RST SM FUSE 1206 47Ω PM5 R
3152	2322 750 64709	RST SM FUSE 1206 47Ω PM5 R
3153	4822 117 13623	51k 1% 0.1W RC12H 0805

Headphone board

-H-

2100	4822 126 14585	100nF 10% 50V
2101	4822 124 81151	22µF 50V
2102	4822 126 14585	100nF 10% 50V
2103	4822 124 81151	22µF 50V
2104	5322 126 10511	1nF 5% 50V
2105	5322 126 10511	1nF 5% 50V

□

3100	5322 117 11726	10Ω 5%
3101	5322 117 11726	10Ω 5%
3102	4822 051 20008	0Ω jumper . (0805)
3104	4822 051 20008	0Ω jumper . (0805)
3106	4822 117 11503	220Ω 1% 0.1W
3107	4822 117 11503	220Ω 1% 0.1W
3108	4822 051 20122	1k2 5% 0.1W
3109	4822 051 20122	1k2 5% 0.1W



7102	4822 209 82362	NJM4556D
7103	4822 130 42615	BC817-40
7104	4822 130 42615	BC817-40

PSU CDR3 ECO

Miscellaneous

0025	4822 492 63524	FIX. TRANSISTOR
0060	4822 492 63524	FIX. TRANSISTOR
0101▲	4822 265 31015	HSC0528
1120▲	4822 070 32002	218002.(2A)
1121	4822 265 11253	FUSE HOLDER 2P

-H-

2102	2238 861 15182	50V 1N8 PM5 R
2104	5322 122 31647	1nF 10% 63V
2106	5322 126 10223	4.7nF 10% 63V
2109	5322 122 31863	63V 330pF PM5
2111	4822 126 14585	100nF 10% 50V
2120▲	4822 121 10697	220nF 20% 275V
2121	8222 675 05480	EL 47µF /400V YK KC RUBYCONF
2127	4822 122 50116	470pF 10% 1KV
2128	4822 121 70141	33nF 5% 400V
2129	4822 124 40769	4.7µF 20% 100V
2131▲	4822 126 14497	2.2nF 20% 250V
2133	4822 124 42084	100µF 20% 35V
2134	4822 124 42084	100µF 20% 35V
2141	4822 124 22652	2.2µF 20% 50V
2142	4822 126 14585	100nF 10% 50V
2150	4822 126 14585	100nF 10% 50V
2161	4822 126 14585	100nF 10% 50V
2201	4822 126 14585	100nF 10% 50V
2202	5322 122 32654	63V 22nF PM10 R
2210	2020 012 93728	EL YK 10V S 2200µF PM20 B
2213	4822 124 41584	100µF 20% 10V
2220	4822 124 40849	330µF 20% 16V
2221	4822 126 13751	47nF 10% 63V
2222	4822 124 42234	100µF 20% 6.3V
2230	4822 124 81144	1000µF 16V
2234	4822 124 81151	22µF 50V
2240	4822 124 40196	220µF 20% 16V
2242	4822 124 41584	100µF 20% 10V
2250	4822 124 40255	100µF 20% 63V
2252	4822 124 40248	10µF 20% 63V
2253	2020 558 90449	DC DE-F 1KV 4N7 P8020 A
2260	4822 122 33177	10nF 20% 50V

□

3102	4822 117 10354	22k 1% 0.1W
3103	4822 051 20339	33Ω 5% 0.1W
3104	4822 116 83933	15k 1% 0.1W
3105	4822 116 83933	15k 1% 0.1W
3106	4822 051 10102	1k 2% 0.25W
3109	4822 051 10102	1k 2% 0.25W
3110	4822 050 21003	10k 1% 0.6W
3111	4822 116 52199	68Ω 5% 0.5W
3112	4822 053 11229	22Ω 5% 2W
3113	4822 051 10102	1k 2% 0.25W
3117▲	4822 053 21684	680k 5% 0.5W

3119	2322 595 90023	VDR DC 1M A/423V S MAX 800V B
3123	4822 050 21803	18k 1% 0.6W
3124	4822 117 12181	470Ω 20% 0.5W
3125	4822 117 10833	10k 1% 0.1W
3126	4822 116 80176	1Ω 5% 0.5W
3127	4822 116 80176	1Ω 5% 0.5W
3128	4822 116 80676	1Ω 5% 0.5W
3129	4822 117 10833	10k 1% 0.1W
3134	4822 050 21803	18k 1% 0.6W
3141	4822 117 10833	10k 1% 0.1W
3142	4822 051 20109	10Ω 5% 0.1W
3150	4822 117 11139	1k5 1% 0.1W
3151	4822 117 11148	56k 1% 0.1W
3201	4822 116 52176	10Ω 5% 0.5W
3202	4822 050 13302	3k3 1% 0.4W
3203	4822 116 52175	100Ω 5% 0.5W
3204	4822 117 10833	10k 1% 0.1W
3205	4822 117 11503	220Ω 1% 0.1W
3206	4822 051 20332	3k3 5% 0.1W
3207	4822 051 10102	1k 2% 0.25W
3208	4822 116 83883	470Ω 5% 0.5W
3221	4822 051 20122	1k2 5% 0.1W
3222	4822 051 20122	1k2 5% 0.1W
3223	4822 117 11596	390Ω 1% 0.1W
3224	4822 116 52199	68Ω 5% 0.5W
3225	4822 116 52199	68Ω 5% 0.5W
3229	4822 117 13085	5k6 1% RC12H 0.1W 0805
3230	4822 050 21002	1k 1% 0.6W
3232	4822 117 11383	12k 1% 0.1W
3233	4822 051 20471	470Ω 5% 0.1W
3234	4822 051 20332	3k3 5% 0.1W
3235	4822 116 52269	3k3 5% 0.5W
4xxx	4822 051 10008	0Ω 5% 0.25W (1206)
4xxx	4822 051 20008	0Ω 5% 0.25W (0805)

5120	4822 157 11846	µH 1922P4
5125	4822 157 11411	100mH z
5130	4822 157 51312	68µH
5131▲	3128 138 38950	SM TRANSFORMER - CT283D3
5210	4822 157 11722	6.8µH 20% 7.7X9.5
5220	4822 157 51462	10µH 10% 4X9.8MM LAL04T100K
5225	4822 157 53139	4.7µH
5226	4822 157 53139	4.7µH
5230	4822 157 50963	2.2µH
5240	4822 157 51462	10µH 10% 4X9.8MM LAL04T100K
5250	4822 157 51462	10µH 10% 4X9.8MM LAL04T100K
5255	4822 157 51195	1 µH 20% 4X9.8MM AXIAL

-H-

6100	4822 130 34281	BZX79-B15
6101	4822 130 34281	BZX79-B15
6102	4822 130 83707	SINB80
6106	4822 130 31603	1N4006
6107	4822 130 31603	1N4006
6129	5322 130 80122	BZX84-C24
6130	4822 130 83649	1SS355
6132	4822 130 42488	BYD33D
6133	4822 130 83649	1SS355
6141	4822 130 10656	UDZ20B
6150	4822 130 11148	UDZ4.7B
6201	9322 107 43685	UDZ22B
6202	9322 102 64685	DIO REG SM UDZ2.7B (RHM0) R
6210	4822 130 83865	SB360
6220	4822 130 42488	BYD33D
6230	4822 130 11415	BYV28-400/20
6240	4822 130 42606	BYD33J
6250	4822 130 32896	BYD33M



7110	9322 145 88682	UC3842A
7125	4822 130 11417	STP3NB60FP
7131▲	4822 130 91451	CQY80NG
7141	4822 130 60373	BC856B
7150	5322 130 60159	BC846B
7201	4822 209 81397	TL431CLPST
7249	4822 209 82112	MC7908CT
7251	4822 130 41344	BC337-40
7252	4822 130 60373	BC856B
7253	4822 130 41246	BC327-25
7254	5322 130 60159	BC846B
7260	8222 675 06290	VOLT.REG.BA12T ROHM

CD MAINBOARD

Miscellaneous

1000	2422 025 11704	CON BM H 16P F 1.00 FFC 0.3 R
1004	2422 543 00896	RES XTL SM 8M4672 30P CX-5F R
1006	4822 267 51454	CONN. 11P FEMALE
1205	5322 242 73686	CST12.00MTW-TF01
1206	4822 252 51173	19398E1(1,000A)
1207	4822 252 51173	19398E1(1,000A)
1208	4822 267 60409	CONN 22P FEMALE
1209	4822 265 30987	BMT 7SR>CBL0.3-1.25
1210	2422 025 11704	CON BM H 16P F 1.00 FFC 0.3 R

-H-

2100	4822 126 14585	100nF 10% 50V
2102	4822 126 14585	100nF 10% 50V
2103	5322 122 31647	1nF 10% 63V
2104	4822 126 14585	100nF 10% 50V
2105	4822 124 81286	47µF 20% 16V
2106	4822 126 14585	100nF 10% 50V
2107	4822 124 81286	47µF 20% 16V
2109	5322 122 32654	63V 22nF PM10 R
2110	4822 126 14585	100nF 10% 50V
2111	4822 126 14585	100nF 10% 50V
2112	4822 126 14585	100nF 10% 50V
2113	4822 126 14585	100nF 10% 50V
2114	4822 126 14585	100nF 10% 50V
2115	4822 126 14585	100nF 10% 50V
2116	4822 124 41796	22µF 20% 16V
2117	4822 126 13561	220nF 10% 16V
2118	4822 126 14585	100nF 10% 50V
2119	4822 126 14585	100nF 10% 50V
2120	4822 124 41796	22µF 20% 16V
2121	4822 126 14585	100nF 10% 50V
2122	4822 126 12104	12nF 5% 50V
2123	5322 122 31863	63V 330pF PM5
2124	4822 126 14585	100nF 10% 50V
2125	4822 124 81286	47µF 20% 16V
2126	5322 122 34098	10nF 10% 63V
2127	5322 122 31863	63V 330pF PM5
2128	4822 124 80483	47µF 20% 6.3V
2130	4822 126 14305	100nF 10% 16V 0603
2131	4822 126 14585	100nF 10% 50V
2132	4822 124 80483	47µF 20% 6.3V
2133	4822 126 13482	470nF 80/20% 16V
2134	4822 126 14305	100nF 10% 16V 0603
2135	4822 124 41796	22µF 20% 16V
2137	4822 126 14494	22nF 10% 25V 0603
2138	4822 126 14494	22nF 10% 25V 0603
2139	4822 126 14305	100nF 10% 16V 0603
2140	4822 126 14508	180pF 5% 50V 0603
2141	4822 126 14238	0603 50V 2N2 COL R
2142	5322 122 32654	63V 22nF PM10 R
2143	4822 126 14241	0603 50V 330P COL R
2145	4822 126 13692	47pF 1% 63V
2146	4822 126 14247	0603 50V 1N5 COL R
2147	4822 126 13482	470nF 80/20% 16V
2148	4822 124 22726	4.7µF 35V
2149	3198 016 36810	0603 25V 680P COL R
2150	4822 126 12105	50V 33nF PM5
2151	5322 124 11919	47µF 20% 6.3V
2152	4822 126 14305	100nF 10% 16V 0603
2153	4822 122 33777	47pF 5% 63V
2154	4822 124 81286	47µF 20% 16V
2155	4822 126 14585	100nF 10% 50V
2156	5322 124 11919	47µF 20% 6.3V
2157	4822 126 14305	100nF 10% 16V 0603
2158	4822 122 33777	47pF 5% 63V
2159	3198 017 34730	0603 16V 47nF COL
2160	4822 126 14494	22nF 10% 25V 0603
2161	5322 124 11919	47µF 20% 6.3V
2162	4822 122 31765	100pF 2% 63V
2163	4822 126 14549	33nF 16V 0603
2164	4822 126 14508	180pF 5% 50V 0603
2165	4822 122 33777	47pF 5% 63V
2166	3198 017 34730	0603 16V 47nF COL
2167	4822 126 14585	100nF 10% 50V
2168	4822 126 13883	220pF 5% 50V
2169	5322 126 10794	220pF 5% 63V
2170	5322 126 10794	220pF 5% 63V
2171	5322 126 10794	220pF 5% 63V
2172	5322 126 10794	220pF 5% 63V
2173	5322 126 10794	220pF 5% 63V
2174	4822 126 14494	22nF 10% 25V 0603
2175	4822 124 81286	47µF 20% 16V
2176	4822 122 33777	47pF 5% 63V

2178	4822 126 14585	100nF 10% 50V
2180	4822 124 41796	22µF 20% 16V
2181	4822 124 41796	22µF 20% 16V
2184	4822 126 14225	56pF 5% 50V 0603
2185	4822 126 14225	56pF 5% 50V 0603
2186	4822 124 81286	47µF 20% 16V
2187	4822 126 14585	100nF 10% 50V
2188	4822 126 14305	100nF 10% 16V 0603
2189	4822 126 14585	100nF 10% 50V
2191	4822 124 81286	47µF 20% 16V
2197	4822 124 81286	47µF 20% 16V
2199	4822 126 13692	47pF 1% 63V
2200	4822 126 14249	560pF 10% 50V CASE0603
2201	4822 126 14247	0603 50V 1N5 COL R
2202	5322 122 32658	22pF 5% 50V
2203	4822 124 22726	4.7µF 35V
2204	4822 126 14585	100nF 10% 50V
2208	4822 124 81286	47µF 20% 16V
2211	4822 126 13692	47pF 1% 63V
2214	5322 122 32658	22pF 5% 50V
2216	4822 126 14305	100nF 10% 16V 0603
2217	4822 122 33777	47pF 5% 63V
2220	4822 126 14585	100nF 10% 50V
2230	5322 126 10223	4.7nF 10% 63V
2232	4822 126 14305	100nF 10% 16V 0603
2233	5322 122 31865	63V 1N5 PM10 R
2234	4822 124 12362	47µF 4V 20%
2235	4822 124 12362	47µF 4V 20%
2252	5322 122 31647	1nF 10% 63V
2280	4822 126 14585	100nF 10% 50V
2285	5322 122 31865	63V 1N5 PM10 R
2286	5322 122 31865	63V 1N5 PM10 R
2300	4822 126 14305	100nF 10% 16V 0603
2301	4822 124 81286	47µF 20% 16V
2302	4822 124 11947	10µF 20% 16V
2303	4822 126 14305	100nF 10% 16V 0603
2304	4822 124 40196	220µF 20% 16V
2306	2222 780 15656	16V 330nF PM10 R
2307	4822 124 40207	100µF 20% 25V
2320	4822 122 33777	47pF 5% 63V
2321	4822 122 33777	47pF 5% 63V
2322	4822 122 33777	47pF 5% 63V
2325	4822 126 14305	100nF 10% 16V 0603
2326	4822 126 14305	100nF 10% 16V 0603
2327	4822 126 14305	100nF 10% 16V 0603



3100	4822 051 20223	22k 5% 0.1W
3101	4822 051 20223	22k 5% 0.1W
3102	4822 051 20479	47Ω 5% 0.1W
3103	4822 117 10834	47k 1% 0.1W
3104	4822 051 30008	0Ω jumper
3105	4822 051 30008	0Ω jumper
3106	4822 051 30008	0Ω jumper
3107	4822 051 30008	0Ω jumper
3113	4822 051 10102	1k 2% 0.25W
3114	4822 051 20822	8k2 5% 0.1W
3115	4822 051 20472	4k7 5% 0.1W
3116	4822 117 10834	47k 1% 0.1W
3117	4822 051 20479	47Ω 5% 0.1W
3130	4822 117 10833	10k 1% 0.1W
3131	4822 117 11151	1Ω 5%
3132	4822 051 20223	22k 5% 0.1W
3134	4822 051 20108	1Ω 5% 0.1W
3135	4822 051 20108	1Ω 5% 0.1W
3136	4822 051 20122	1k2 5% 0.1W
3137	4822 117 11504	270Ω 1% 0.1W
3138	4822 117 11504	270Ω 1% 0.1W
3139	4822 117 10833	10k 1% 0.1W
3140	4822 051 20008	0Ω jumper . (0805)
3141	4822 051 20008	0Ω jumper . (0805)
3142	4822 117 11504	270Ω 1% 0.1W
3143	4822 117 10834	47k 1% 0.1W
3144	4822 117 10834	47k 1% 0.1W
3145	4822 117 11504	270Ω 1% 0.1W
3146	4822 117 10837	100k 1% 0.1W
3148	4822 051 20008	0Ω jumper . (0805)
3149	4822 051 10102	1k 2% 0.25W
3150	4822 117 11383	12k 1% 0.1W
3151	4822 117 11383	12k 1% 0.1W
3152	4822 051 20008	0Ω jumper . (0805)
3153	4822 051 30101	100Ω 5% 0.062W
3154	4822 117 11151	1Ω 5%
3155	4822 051 20008	0Ω jumper . (0805)
3156	4822 117 11383	12k 1% 0.1W
3157	4822 117 11383	12k 1% 0.1W
3158	4822 051 20122	1k2 5% 0.1W
3159	4822 051 20008	0Ω jumper . (0805)
3160	4822 117 10833	10k 1% 0.1W
3161	4822 117 11748	2Ω 1206 5% FUSE
3162	4822 117 11748	2Ω 1206 5% FUSE
3164	4822 051 20479	47Ω 5% 0.1W

3168	4822 117 11373	100Ω 1% RC12H 0805
3169	4822 051 30272	2k7 5% 0.062W
3171	4822 051 30103	10k 5% 0.062W
3172	4822 117 11373	100Ω 1% RC12H 0805
3173	4822 117 11452	430Ω 1% 0.1W
3174	4822 117 11452	430Ω 1% 0.1W
3176	4822 117 11373	100Ω 1% RC12H 0805
3177	4822 117 11151	1Ω 5%
3178	4822 051 30102	1k 5% 0.062W
3179	4822 051 30102	1k 5% 0.062W
3180	4822 051 30272	2k7 5% 0.062W
3181	4822 051 20223	22k 5% 0.1W
3182	4822 051 30391	390Ω 5% 0.062W
3183	4822 051 30103	10k 5% 0.062W
3184	4822 117 11748	2Ω 1206 5% FUSE
3185	4822 051 30472	4k7 5% 0.062W
3186	4822 051 30472	4k7 5% 0.062W
3187	4822 051 30391	390Ω 5% 0.062W
3188	4822 051 30272	2k7 5% 0.062W
3189	4822 051 30391	390Ω 5% 0.062W
3190	4822 117 11456	30k 1% 0.1W
3191	4822 117 11452	430Ω 1% 0.1W
3192	4822 117 11452	430Ω 1% 0.1W
3193	4822 051 30181	180Ω 5% 0.062W
3194	4822 051 20008	0Ω jumper . (0805)
3195	4822 051 20008	0Ω jumper . (0805)
3196	4822 051 30102	1k 5% 0.062W
3197	4822 117 10833	10k 1% 0.1W
3198	4822 051 30479	47Ω 5% 0.062W
3199	4822 051 30152	1k5 5% 0.062W
3200	4822 117 10833	10k 1% 0.1W
3201	4822 117 11817	1k2 1% 1/16W
3202	4822 051 30223	22k 5% 0.062W
3203	4822 051 30272	2k7 5% 0.062W
3204	4822 051 20008	0Ω jumper . (0805)
3205	4822 051 30103	10k 5% 0.062W
3206	4822 051 30008	0Ω jumper
3208	4822 117 13608	4.7Ω 5% 0603 0.0016W
3212	4822 051 30105	1M 5% 0.062W
3214	4822 051 20008	0Ω jumper . (0805)
3215	4822 117 11748	2Ω 1206 5% FUSE
3216	4822 117 11748	2Ω 1206 5% FUSE
3217	4822 117 10833	10k 1% 0.1W
3218	4822 051 10102	1k 2% 0.25W
3219	4822 117 13573	NETW 4 X 47Ω 5% MNR14
3220	4822 051 30103	10k 5% 0.062W
3225	4822 117 11748	2Ω 1206 5% FUSE
3226	4822 117 10833	10k 1% 0.1W
3229	4822 117 11748	2Ω 1206 5% FUSE
3233	4822 117 10354	22k 1% 0.1W
3235	4822 051 30008	0Ω jumper
3236	4822 051 20008	0Ω jumper . (0805)
3237	4822 051 20008	0Ω jumper . (0805)
3241	4822 117 10354	22k 1% 0.1W
3242	4822 117 10833	10k 1% 0.1W
3243	4822 117 10834	47k 1% 0.1W
3245	4822 117 10834	47k 1% 0.1W
3248	4822 117 10354	22k 1% 0.1W
3254	4822 117 10354	22k 1% 0.1W
3256	4822 117 10833	10k 1% 0.1W
3258	4822 117 10834	47k 1% 0.1W
3260	4822 117 10834	47k 1% 0.1W
3263	4822 117 11748	2Ω 1206 5% FUSE
3265	4822 117 10837	100k 1% 0.1W
3266	4822 051 10102	1k 2% 0.25W
3267	4822 051 30102	1k 5% 0.062W
3268	4822 117 10837	100k 1% 0.1W
3269	4822 117 11373	100Ω 1% RC12H 0805
3270	4822 117 10833	10k 1% 0.1W
3271	4822 117 11373	100Ω 1% RC12H 0805
3273	4822 117 11373	100Ω 1% RC12H 0805
3274	4822 117 11373	100Ω 1% RC12H 0805
3275	4822 117 11373	100Ω 1% RC12H 0805
3276	4822 117 11373	100Ω 1% RC12H 0805
3277	4822 117 11373	100Ω 1% RC12H 0805
3278	4822 051 20008	0Ω jumper . (0805)
3279	4822 117 11151	1Ω 5%
3280	4822 117 10833	10k 1% 0.1W
3282	4822 051 30103	10k 5% 0.062W
3283	4822 117 10833	10k 1% 0.1W
3284	4822 051 30008	0Ω jumper
3285	4822 051 30472	4k7 5% 0.062W
3286	4822 051 30154	150k 5% 0.062W
3287	4822 117 12925	47k 1% 0.063W 0603
3300	4822 051 30103	10k 5% 0.062W
3302	4822 051 30103	10k 5% 0.062W
3303	4822 051 30103	10k 5% 0.062W
3304	4822 051 30103	10k 5% 0.062W
3305	4822 051 30103	10k 5% 0.062W
3306	4822 051 30103	10k 5% 0.062W
3307	4822 051 30103	10k 5% 0.062W
3308	4822 117 11748	2Ω 1206 5% FUSE
3310	4822 051 10102	1k 2% 0.25W
3312	4822 051 10102	1k 2% 0.25W

3313	4822 117 10833	10k 1% 0.1W
3314	4822 117 10833	10k 1% 0.1W
3318	4822 117 11373	100Ω 1% RC12H 0805
3319	4822 117 11373	100Ω 1% RC12H 0805
3320	4822 117 11373	100Ω 1% RC12H 0805
3328	4822 051 20105	1M 5% 0.1W
3331	4822 117 11373	100Ω 1% RC12H 0805
3333	4822 051 30101	100Ω 5% 0.062W
3335	4822 051 30103	10k 5% 0.062W
3337	4822 051 30103	10k 5% 0.062W
3339	4822 051 30103	10k 5% 0.062W
3342	4822 117 10833	10k 1% 0.1W
3350	4822 051 10102	1k 2% 0.25W
3352	4822 051 20008	0Ω jumper . (0805)
3353	4822 117 11373	100Ω 1% RC12H 0805
3354	4822 117 11373	100Ω 1% RC12H 0805
3355	4822 117 11373	100Ω 1% RC12H 0805
3356	4822 117 11373	100Ω 1% RC12H 0805
3357	4822 051 20008	0Ω jumper . (0805)
3359	4822 051 20008	0Ω jumper . (0805)
3360	4822 051 20008	0Ω jumper . (0805)
3361	4822 117 11373	100Ω 1% RC12H 0805
3999	4822 117 12842	SM RST 0805 PROCESS CHIP



6000	4822 130 11382	BYG50D
6001	4822 130 11382	BYG50D
6002	4822 130 11382	BYG50D
6003	4822 130 83757	BAS216



7000	9352 641 80557	SAA7324H/M2B
7005	9337 143 50653	74HCT08
7006	5322 130 42718	BFS20
7007	4822 130 60373	BC856B
7008	5322 130 42718	BFS20
7009	5322 130 42718	BFS20
7010	5322 130 60159	BC846B
7011	5322 130 42718	BFS20
7019	4822 130 60373	BC856B
7020	4822 209 16877	BA6856FP
7021	4822 209 32852	TDA7073A/N2
7022	4822 209 32852	TDA7073A/N2
7023	5322 130 42718	BFS20
7025	9337 153 10118	IC SM 74HCT4052D (PHSE) R
7120	4822 209 30095	LM833D
7130	5322 130 60159	BC846B
7131	4822 130 60373	BC856B
7132	5322 130 60159	BC846B
7203	5322 130 60159	BC846B
7204	4822 209 17398	LD1117DT33
7301	5322 130 60159	BC846B
7309	4822 209 17237	UDA1320ATS
7310	5322 130 60159	BC846B